

MatGuard™ Mats

Description

The MatGuard safety mat is a pressure-sensitive safeguarding product that is designed to detect the presence of people on its sensing surface.

The MatGuard safety mat has two conductive hardened steel plates that are held apart by non-conductive compressible separators. Each four-wire mat, operating on only 24V DC, is pre-wired and connected in series with other mats to form a floor level guarding system for hazardous areas. The circuit through the mat must be monitored by a safety-rated control unit, which may be a Minotaur Safety Relay, MatGuard control unit, or MatGuard Mat Manager. When the mat is clear, the control unit provides a signal to the machine control circuit.

When a mat is stepped on, the conductive plates touch and the resistance in the circuit falls to zero. This is monitored by the control unit, which sends a shutdown signal to the machine.

Since the MatGuard safety mat is completely sealed (IP67), water, liquids and coolants present no problem. In addition, the tough vinyl will resist bleaches, acids, salts and many industrial chemicals.

The unique molding process allows the long life and reliability of the mat.

Features

- Hardened steel plate construction
- No dead spots
- 4-wire system to detect opens and shorts
- Can withstand a static pressure of 4500 psi
- IP67 rated

Specifications

Standards	EN1760-1, EN954-1, ISO 13849-1, IEC/EN60204-1, ANSI RIA R15.06, ANSI/B11.19, AS4024.5
Category	Cat. 1 device per EN954-1, suitable for Cat. 3 systems
Certifications	CE Marked for all applicable directives, cULus Listed, CSA Z432-04, and TÜV
Power Supply	24V DC, -20% +10%, provided by the control unit
Connection Wire Length, Max.	200 m (656 ft)
Cable Length	4.5 m (15 ft) standard (see Product Selection)
Detection Weight	30 kg (66 lbs) minimum on an 80 mm (3.125 in.) diameter circular disk
Maximum Pressure Applied to Mat	31,034 kPa (4500 psi)
Zone Size	100 m ² (1076 ft ²), maximum
Mechanical Life	10,000,000 operations
Operating Temperature [C (F)]	-25...55° (-14...131°)
Relative Humidity	100%
Enclosure Type Rating	IP67 (NEMA 6P)
Vibration	5 g, 10...200 Hz
Shock	11 ms 10 g/16 ms 10 g
Terminal Protection	IP 20 DIN 0470
Wire Size	0.75 mm ² (18 AWG), 2 wire; 3.8 mm x 7.4 mm (0.15 in. x 0.29 in.) jacket OD
Weight	10.9 kg/m ² (2.2lbs/ft ²)
Material	Plastisol Vinyl
Color	Yellow or Black
Trim Material	6063 Aluminum
Mounting	Flat surface
Thickness	16 mm (0.63 in.)

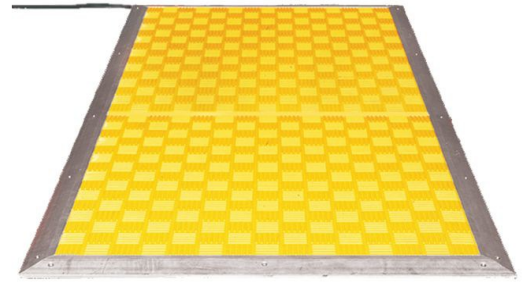

Mat Size [mm (in.)]	Cat. No.	
	Standard Perimeter Trim Kit	Safety Mat
500 x 500 (19.7 x 19.7)	440F-T1010	440F-M1010BYNN
500 x 1500 (19.7 x 59.1)	440F-T1030	440F-M1030BYNN
500 x 750 (19.7 x 29.5)	440F-T1510	440F-M1015BYNN
750 x 750 (29.5 x 29.5)	440F-T1515	440F-M1515BYNN
750 x 1500 (29.5 x 59.1)	440F-T1530	440F-M1530BYNN
500 x 1000 (19.7 x 39.4)	440F-T2010	440F-M1020BYNN
750 x 1000 (29.5 x 39.4)	440F-T2015	440F-M1520BYNN
1000 x 1000 (39.4 x 39.4)	440F-T2020	440F-M2020BYNN
1000 x 1250 (39.4 x 49.2)	440F-T2025	440F-M2025BYNN
1000 x 1500 (39.4 x 59.1)	440F-T2030	440F-M2030BYNN
1000 x 1800 (39.4 x 70.9)	440F-T1836	440F-M2036BYNN
Recommended control unit. For other control units, see Product Selection .		440R-C23139

Examples

Standard System Configurations

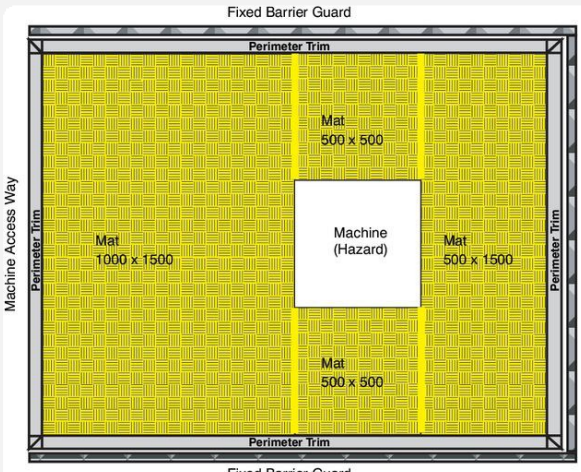
	Bill of Materials		
	Description	Quantity	Cat. No.
Mat	1	440F-M2030BYNN	
	2	440F-M1010BYNN	
Mat	1	440F-M1030BYNN	
Perimeter Trim*	2	440F-T3210	
Perimeter Trim*	1	440F-T3310	
Active uniting trim (used to join two mats to ensure no dead spots)	1	440F-T3220	
MatGuard Controllers	1	440F-C4000S	
Corner Trim	4	440F-T3012	

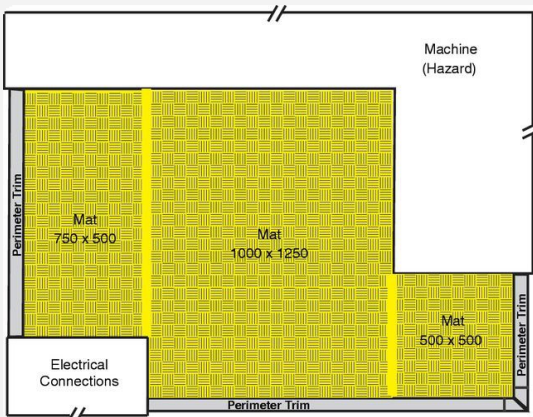
	Bill of Materials		
	Description	Quantity	Cat. No.
MatGuard Safety Mats	1	440F-M2025BYNN	
	1	440F-M1010BYNN	
	1	440F-M1510BYNN	
Perimeter Trim*	1	440F-T3310	
Corner Trim	1	440F-T3012	
Uniting Trim	2	440F-T3020	
MatGuard Controllers	1	440F-C4000P	

* Customer must cut trim to proper length.

Product Selection—Configurable Mats

MatGuard safety mat and trim kit cat. nos. can be configured by selecting the appropriate codes from the tables below.

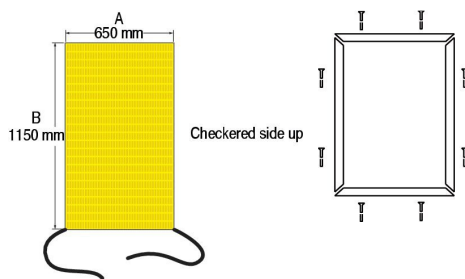

Mats: 440F M 13 23 A Y NN Trim Kit: 440F I 13 23
a b c d e a l

a	
"A" Dimension [mm (in.)]	
Code	Description
2 digit number	Length of the mat in millimetres/50 Must be in 50 (1.97) increments Min. allowed 150 (03); Max. allowed 1000 (20) The length of A must be equal to or shorter than B.

b	
"B" Dimensions [mm (in.)]	
Code	Description
2 digit number	Length of the mat in millimetres/50 Must be in 50 (1.97) increments Min. allowed 200 (04); Max. allowed 1800 (36) The length of A must be equal to or shorter than B.





c	
Cable Exit	
Code	Description
A	Two 4.5 m (15 ft) 2-wire cables—exit out the A corners
B	Two 4.5 m (15 ft) 2-wire cables—exit out the B corners
C	One 9.1 m (30 ft) 4-wire cable with M12 male connector exits out of upper left corner
D	One 9.1 m (30 ft) 4-wire cable without connector exits out of upper left corner
F	One 0.76 m (2.5 ft) 4-wire cable with M12 male connector exits out of upper right corner
G	One 9.1 m (30 ft) 4-wire cable with M12 male connector exits out of upper left corner for use with 898D Distribution Box
H	One 9.1 m (30 ft) 5-wire cable with M12 male connector exits out of upper left corner for use with ArmorBlock Guard I/O

d	
Color	
Code	Description
B	Black
Y	Yellow





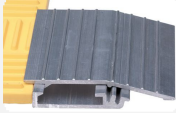

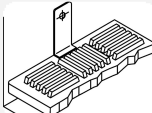
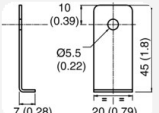
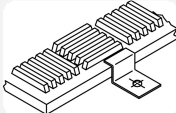
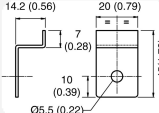

e	
Trim Options	
Code	Description
K	Cable Channel Trim
T	Standard Trim

Note: Order controller separately, see MatGuard™ Controllers for selection details.

Product Selection, Trim Options

Type	Description	Length	Cat. No.
	Standard perimeter trim (aluminum) for use with up to 3 cables running through channel.	2 m, square ends	440F-T3210
		3 m, square ends	440F-T3310
	Aluminum external corner standard perimeter trim	See Standard Perimeter Trim	440F-T3012
	Aluminum internal corner standard perimeter trim		440F-T3013
	Aluminum perimeter trim with cable channel. Used when up to 8 cables need to be fed through channel.*	2 m, square ends	440F-T3211
		3 m, square ends	440F-T3311
		4 m, square ends	440F-T3411
	Aluminium external corner perimeter trim with cable channel	See Perimeter Trim with Cable Channel	440F-T3014
	Internal corner perimeter trim with cable channel		440F-T3015

Accessories

Type	Description	Dimensions	Cat. No.
	Aluminum right angle perimeter trim	13 x 25 mm, 2 m length (½ x 1 in., 6.6 ft length)	440F-T3216
		13 x 25 mm, 3 m length (½ x 1 in., 9.8 ft length)	440F-T3316
	Stainless steel angle clip perimeter trim (5 per package)		440F-T102933
	Stainless steel z-clip perimeter trim (5 per package)		440F-T102935
	Active uniting trim (used to join two mats to ensure no dead spots)	1 m (3.28 ft) length, square ends	440F-T3120
		1.5 m (4.9 ft) length, square ends	440F-T3020
		2 m (6.5 ft) length, square ends	440F-T3220
		3 m (9.8 ft) length, square ends	440F-T3320
	Vinyl wire guide	63.5 mm (2.5 in.) width, 2 m (6.6 ft) length	440F-T3230
	Accessories kit for 440F-C4000S and 440F-C4000P. 4 butt splices, 2 500 mA fuses, 4 wire terminations	N/A	440F-A108433
	12 Philips flat head, stainless steel screws for 440F-T3211 and 440F-T3411 channel trim. Secures top to the bottom.	#6 x 9.5 (3/8)	440F-A17143
	12 Philips flat head, stainless steel screws with anchors for 440F-T3210, 440F-T3310, and 440F-T3510 trim	#10 x 38 (1.5)	440F-A17141
	12 flat head, stainless steel screws with anchors for 440F-T3211 and 440F-T3411 channel trim	#10 x 32 (1.25)	440F-A17142
	DC micro QD cordset, straight, 4-pin, 2 m (6.5 ft) 1 Brown 2 White 3 Blue 4 Black	2 m (6.5 ft)	889D-F4AC-2
		5 m (16.4 ft)	889D-F4AC-5
		10 m (32.8 ft)	889D-F4AC-10
		15 m (49.2 ft)	889D-F4AC-15
		20 m (65.6 ft)	889D-F4AC-20
		30 m (98.4 ft)	889D-F4AC-30
Reset push button for Mat Manager controllers			800FP-FOPN3YX11

Approximate Dimensions

Dimensions are shown in mm (in.). Dimensions are not intended to be used for installation purposes.

Mat System

When more than one mat is needed to protect an area, use the dimensions below to determine how large of an area is covered.

PLEASE SUPPLY A SKETCH LAYOUT FOR MULTIPLE MATS

When calculating the overall area of layout add 'X', 'Y' & 'Z' to allow for Perimeter trim and joints.

Active Uniting Trim

When pressure is applied, the uniting trim causes the mat to deflect and change state, therefore giving all over sensitivity even on the joints.

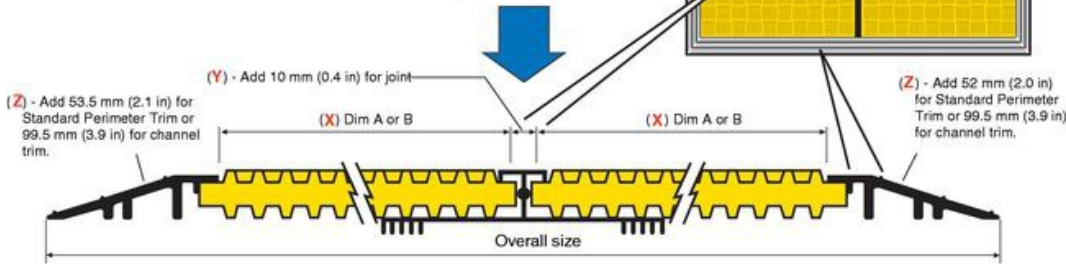

IMPORTANT

Use the Distance Calculation on [Application Details](#) to ensure adequate coverage around the hazard.

Standard Perimeter Trim

Internal and External Corners

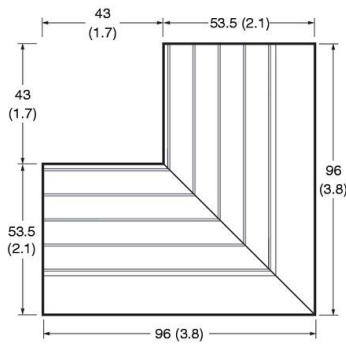

Channel Dimensions

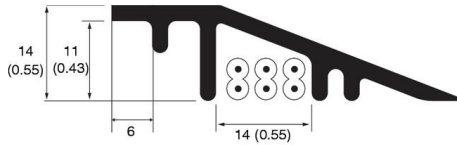

Standard perimeter trim holds three standard 2-wire mat cables or 2 4-wire cables. The equivalent of two cables are needed when connecting two mats in series.

Perimeter Trim with Cable Channel

Internal and External Corners

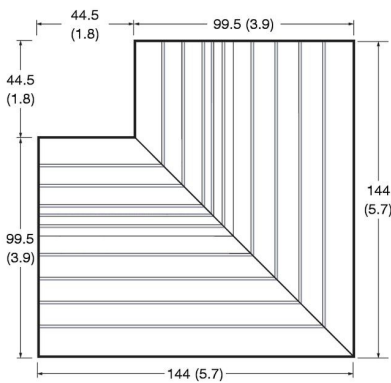

Channel Dimensions

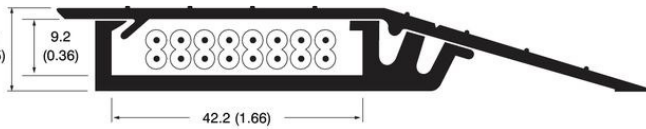

Cable channel trim holds up to 8 standard 2-wire mats cables or 7 4-wire cables even when going around corners.

Connectivity

Two-Wire Cable Option

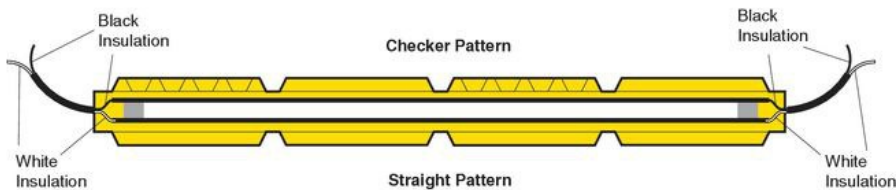

Note: Flat cable O.D. 6.5 mm x 3.5 mm

4-Pin Micro M12 Connector Option [mm (in.)]

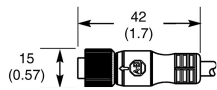

Checked Rib Side of Mat

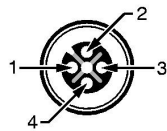

Straight Male

Straight Rib Side of Mat

Connection Cables

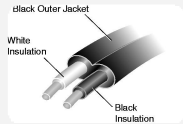
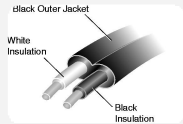
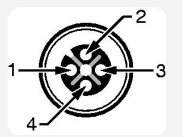
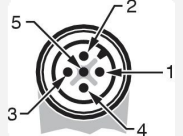
Cable Exit Configuration Code	Description	Compatibility	Connector	Wire Color	Circuit
A	Two 4.5 m (15 ft) 2-wire cables—exit out the A corners	Safety Relays		Black Black	N.C.
B	Two 4.5 m (15 ft) 2-wire cables—exit out the B corners	Safety Relays		White White	N.C.
C	One 9.1 m (30 ft) 4-wire cable with M12 male connector exits out of upper left corner	Mat Managers		1 Brown 2 White	N.C.
D	One 9.1 m (30 ft) 4-wire cable without connector exits out of upper left corner	Safety Relays		3 Blue 4 Black	N.C.
F	One 0.76 m (2.5 ft) 4-wire cable with M12 male connector exits out of upper left corner	Mat Managers		1 Brown 2 White	N.C.
G	One 9.1 m (30 ft) 4-wire cable with M12 male connector exits out of upper left corner	Distribution Block (2 N.C.) 898D-4*LT-DM4		3 Blue 4 Black	N.C.
H	One 9.1 m (30 ft) 5-wire cable with M12 male connector exits out of upper left corner	ArmorBlock Guard I/O		1 Brown 2 White	N.C.
				4 Black 5 Grey	N.C.

Connection to Logic Interfaces

Description	Safety Outputs	Auxiliary Outputs	Terminals	Reset Type	Power Supply	Cat. Page No.	Cat. No.
Single-Function Safety Relays							
MSR131RTP	3 N.O.	2 N.C., 2 PNP solid state	Removable (Screw)	Auto./Manual or Monitored Manual	24V AC/DC	Description	440R-C23139
MSR30RT	2 N.O. Solid State	1 N.O. Solid State	Removable	Auto./Manual or Monitored Manual	24V DC	Description	440R-N23198
Specialty Safety Relays							
MSR23M	2 N.O.	1 N.C.	Fixed	Automatic/Manual Monitored Manual	24V AC/DC	Description	440R-P23073
Mat Controller	2 N.O.	1 N.C.	Fixed	Automatic/Manual Monitored Manual	24V AC/DC or 115/230V AC	Description	440F-C4000S
Mat Manager	2 N.O.	1 N.C.	Fixed	Auto./Manual Monitored Manual	24V DC	Description	440F-C28011
Modular Safety Relays							
MSR210P Base (2 N.C.)	2 N.O.	1 N.C. and 2 PNP Solid State and 2 PNP Solid State	Removable	Auto./Manual or Monitored Manual	24V DC from the base unit	Description	440R-H23176
MSR220P Input Module (all)	—	—	Removable	—	24V DC	Description	440R-H23178
MSR320P Input Module (all)	—	2 PNP Solid State	Removable	—	24V DC from the base unit	Description	440R-W23218

Note: For additional Safety Relays connectivity, see the Logic section of this catalog. For additional Safety I/O connectivity, see the Safety I/O section of this catalog. For Application and wiring diagrams, see the Applications section of this catalog.

Connection Systems

Connection	4-Pin	5-Pin
Cordset	889D-F4AC-*	889D-F5AC-*
Patchcord	889D-F4ACDM-‡	889D-F5ACDM-‡
Distribution Box	898D-4S LT-DM4	NA
Shorting Plug	898D-41LU-DM	NA
T-Port	898D-43LY-D4	NA

* Replace symbol with 2 (2 m), 5 (5 m), or 10 (10 m) for standard cable lengths.
‡ Replace symbol with 1 (1 m), 2 (2 m), 3 (3 m), 5 (5 m), or 10 (10 m) for standard cable lengths.
§ Replace symbol with 4 or 8 for number of ports.

Typical Wiring Diagrams

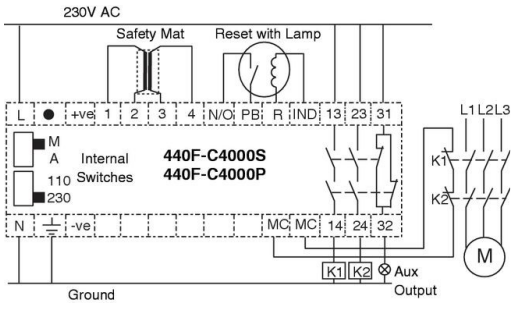

Safety Mat, Monitored Manual Reset, Dual Channel Output, Monitored Output

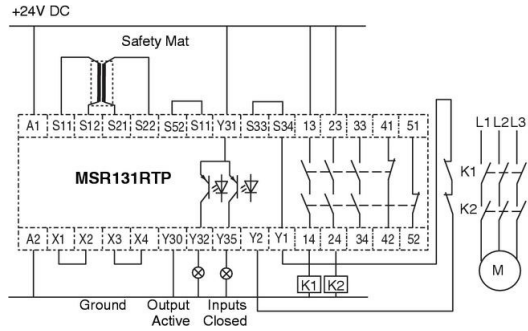

Safety Mat, Automatic Reset, No Output Monitoring

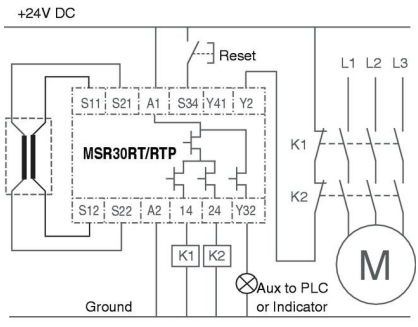

Safety Mat, Dual Channel Output Monitored, Manual Reset, Output Monitoring

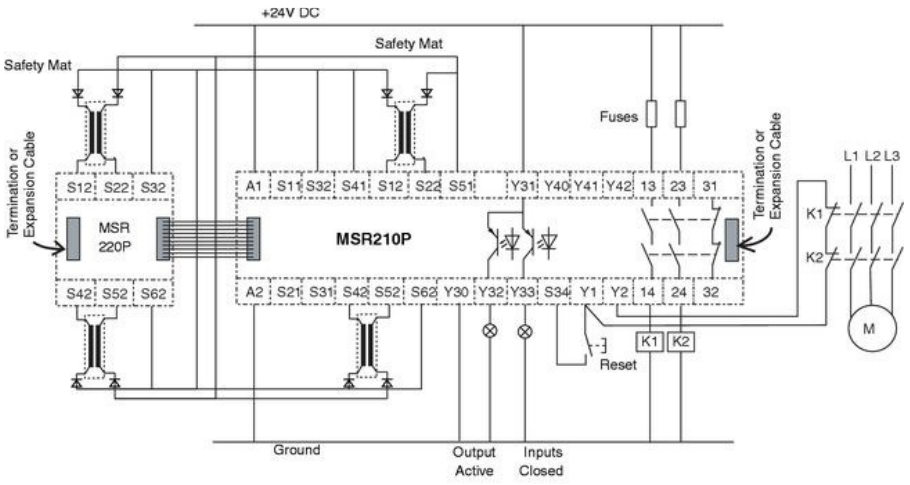

Four Individually Monitored Safety Mats, Monitored Manual Reset, Dual Output, Output Monitoring

Note: The diodes shown can be terminal blocks with built-in diodes (1492-JD3DF or 1492-JD3DR).

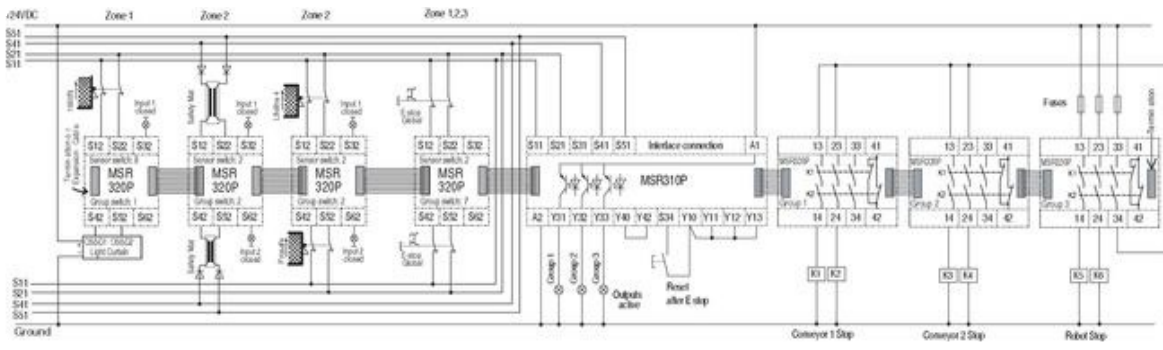

Note: The diodes shown can be terminal blocks with built-in diodes (1492-JD3DF or 1492-JD3DR).

