



**Overview**

An enabling device is a manually operated control device used in conjunction with a start control. The safety function of the enabling switch has two parts: 1) when continuously actuated, the enabling device allows machine operation, and 2) when not actuated, the enabling device initiates a stop command to prevent machine operation.

Historically, many enabling devices used a two-position switch. In the event of an unexpected incident, the two-position switch is designed to open when the muscles relax. The three-position switch provides enhanced performance as it is designed to open when the muscles either relax or contract. The trend in machine safeguarding is towards the use of three-position switches. Various types of devices use the three-position switch as enabling devices. These are typically push buttons, grip switches and foot switches.

The Rockwell Automation 440J is a hand-operated grip style enabling device. Underneath the rubber boot, called the trigger switch, the 440J enabling device has two three-position switches. The contacts are closed when the actuator is in the mid-position (partly depressed). The contacts are open when the actuator is in the rest (released) position and in the fully pressed position. When transitioning from fully pressed to released, the contacts remain open. The 440J meets the requirements of IEC 60947-5-8:2006, which was written to describe the performance and design requirements of three-position enabling devices.

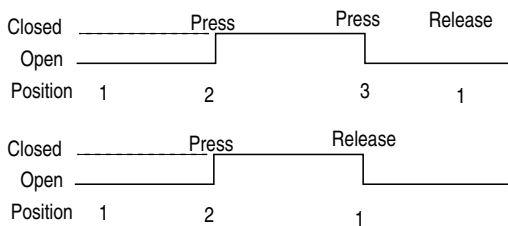
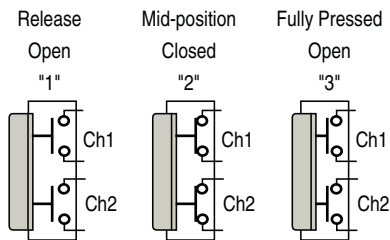

Enabling devices are typically used when access to the hazardous portion of the machine is needed while the machine is running. Visual observations, minor adjustments, troubleshooting, calibration, tool changes, and lubrication are examples of tasks that may utilize an enabling device. Before accessing the machine, the operator must usually place the machine in a reduced performance role. A risk assessment must be performed to determine the level of reduced performance. The concept is that in the event of an unexpected event, the operator will either release or squeeze the actuator of the enabling device and disable the machine, prior to getting injured.

The 440J enabling switches come in three models: 1) standard switch with no additional buttons, 2) switch with an additional single normally open contact, and 3) switch with an additional dual channel e-stop button.

The model with the normally open contact is typically used as a jog or reset function. The safety system design must only allow the use of the jog or reset function when the trigger switch is in the mid-position.

The e-stop button has two normally closed contacts with direct opening action. The e-stop button latches when the contacts open per IEC 60947-5-5 and ISO 13850. When this model is selected with the quick disconnect option, the user must store the enabling switch in an out-of-sight location if it is disconnected.

**Mounting Considerations**

All three 440J enabling switches come with a base plate. All three models are offered with either a cable strain-relief or an M12 micro quick-disconnect connector.

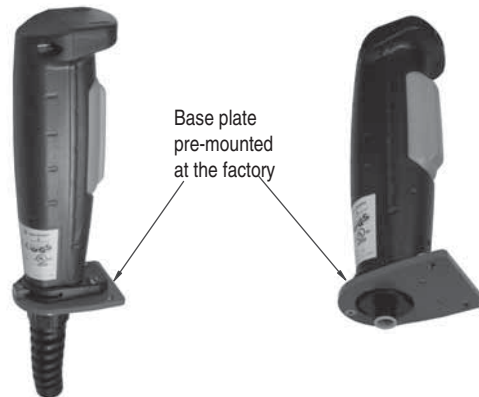

Cable Strain Relief

M12 Micro Quick Disconnect

In some applications, the operation of the switch contacts is all that is needed. In this case, the holding bracket 440J-A00N is used.



440J-A00N



Additional accessory brackets can be added to achieve various arrangements. The 440J-A01N right angle bracket is designed to accommodate the 440K-A11238 (standard actuator) which is used with the standard Trojan 6 or Trojan T15 and the 440G-A27011 (GD2 actuator) which is used with the GD2 interlocks.



440J-A01N  
 Bracket  
 Shown with  
 GD2 Actuator

With two additional screws, the right angle bracket can be mounted to the 440J enabling switch for horizontal mounting. An actuator can also be mounted for vertical use without the 440J-A01N bracket.



Shown with  
 440G-A27011  
 GD2 Actuator

Horizontal Mounting



Shown with  
 440K-A11095  
 Standard Actuator

Vertical Mounting

Mounting plate 440J-A02N has multiple pre-drilled and tapped holes to facilitate mounting of a single 440K-MT (MT-GD2) or 440K-T (Trojan) interlock. Four additional through-holes at the corners allow mounting of the plate to a flat surface.

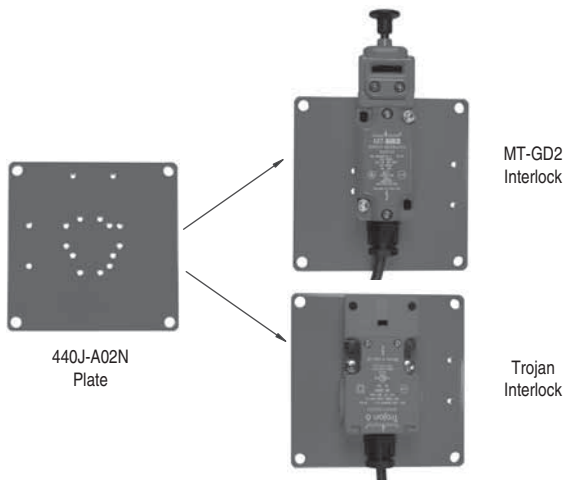

440J-A02N  
 Plate

MT-GD2  
 Interlock

Trojan  
 Interlock

The recommended method for single-switch mounting is to use the 440K-MT (MT-GD2) with the latch release. The latch holds the contacts closed when the enabling switch is bumped or rattled. An alternative is to use the 440K-T (Trojan 6 or T15) with a vertical mounting. The holding force of these interlocks is enough to keep the contacts closed under minor bumps and rattles.



Horizontal Mount  
 with MT-GD2



Vertical Mount  
 with Trojan

In some applications, additional contacts are needed when the enabling switch is used. Two additional accessories are used to allow the enabling switch to interact with two interlocks.

The 440J-A03N accessory mounts to the enabling switch base plate. This accessory has two sets of holes to accommodate either two standard or two GD2 actuators. This arrangement is used in conjunction with the 440K-A04N accessory.



440J-A03N



Enabling Switch mounted on  
 440J-A03N, shown with  
 two standard actuators

The U-shaped 440J-A04N can accommodate two interlocks: either 440K-MT or 440K-T. Using the 440J-A03N plate with dual actuators, a total of eight contacts, four in each switch, can be made available for the safety and control system.

The MT-GD2 with the manual latch release should be used for horizontal actuator mounting. The Trojan should only be used with vertical mounting. To use the 440K-T (Trojan 6 or T15), the head must be rotated 180°. The Trojan GD2 models cannot be used with the 440J-A02N as its head cannot be rotated.

Application Considerations

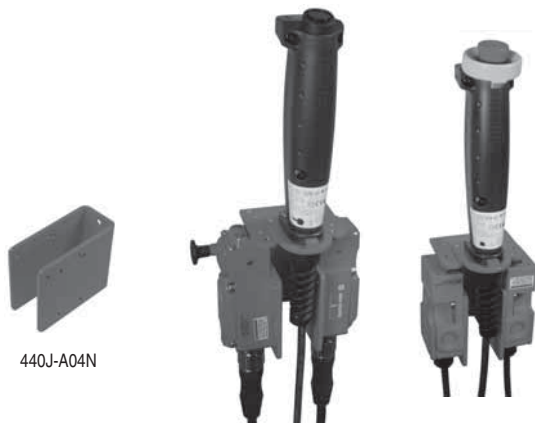

Dual Interlock Switches  
 Provide Eight Contacts

Safety system designers will quickly realize that the enabling device by itself is easy to understand; it is simply a set of contacts. The application of the enabling device into a machine safeguarding system is the challenge.

Consideration must be given to the following:

1. Setting the machine in reduced performance mode.

In some cases, the speed or other characteristic of the machine must be reduced to allow the operator to avoid the hazard by releasing or squeezing the trigger switch. The control system must be designed so that the machine is not changed back to normal performance during the enabling task. A key-operated mode selector switch is one method of setting the machine in a reduced performance mode. The operator selects reduced mode and then removes the key from the switch, taking the key with him or her. Holding the trigger switch then allows the hazard to operate in a reduced mode.

2. Knowing the machine is in reduced performance mode

Sensors can be used to determine that reduced performance of the machine is maintained. Position sensors, encoders or other devices, monitored by an appropriated logic device, provide feedback to the control system. If the performance (e.g., operating speed) were to increase beyond a predetermined limit, the control system would execute a stop command. Releasing the enabling device could also be used to execute a stop command.

3. Type of access

The safety system architecture will differ depending on whether partial body or full body access is required.

When partial body access is required, the enabling device must continuously bypass the primary safeguard (e.g. gate interlock, light curtain, safety mat, or safety scanner). Enabling devices must only bypass one primary safeguard—bypassing multiple safeguards with one enabling device must be avoided as access to the hazard may not be detected by the other bypassed safeguards.

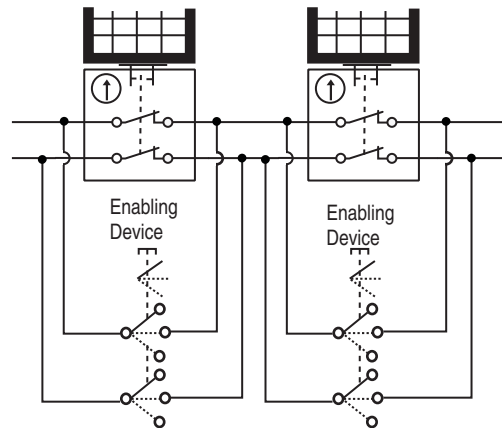

If full body access is required, consideration must be given to whether the primary safeguard can or must be active during the operation of the enabling device. With the primary safeguard active, additional entries into the hazard area will be detected. If the primary safeguard must remain inactive, administrative procedures must ensure that additional personnel do not enter the hazard area.

4. Multiple Personnel Access

When more than one person must access the hazard, all persons must utilize their own enabling device. All enabling devices must be active to energize the hazard.

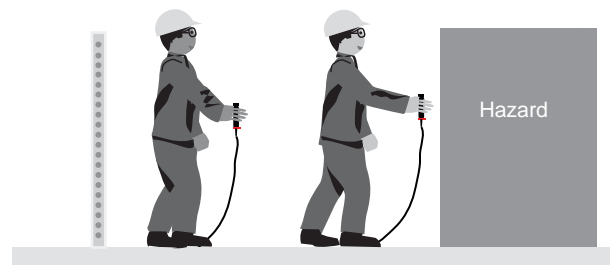

The table below summarizes when additional interlocking devices must be used in conjunction with the enabling device. For partial body access, three cases exist, depending on the type of device being bypassed and the logic unit used by the safety system.

1. The enabling switch can be connected directly across the safeguarding device that has dry contacts.
2. Devices with OSSD outputs, like the GuardShield Light curtain will need a single interlock with four contacts to avoid nuisance faults when a monitoring safety relay is used as the safety system logic device.
3. When a safety PLC is used as the logic device, the enabling device can be connected to separate inputs and internal programming logic can be used to bypass the light curtain when the enabling switch is needed.

For full body access, there are two cases, which depend on the logic device used by the safety system.

1. When a safety PLC is used, a single interlock with four contacts is needed. These four contacts are used to interlock the safety system reset function and the machine start function.
2. When a monitoring safety relay is used, two interlocks with four contacts each are needed. Four contacts are used to bypass the primary safeguarding device. Two contacts are used to reset the safety system. Two contacts are used to interlock the machine start control to prevent starting of the machine from the control panel.

Access Type	Safeguard Type	Logic Device	Interlocks Required
Partial Body	Dry Contact Interlocks (e.g., Elf, Cadet, Trojan, MT-GD2, Sipher, Ferrogard, 440G-MT, TLS-GD2, Atlas)	Monitoring Safety Relay or Safety PLC	None
	Devices with OSSD Outputs (e.g., GuardShield Light Curtain, SensaGuard, SafeZone Multizone)	Safety PLC	
Full Body	All Types	Monitoring Safety Relay	Single Interlock with Four Contacts
		Safety PLC	Single Interlock with Four Contacts
		Monitoring Safety Relay	Dual Interlocks, each with Four Contacts



### Description

The three position enabling switch can be used as part of the conditions required to allow safe working inside a machine guard, e.g., set-up, maintenance, or troubleshooting. It is lightweight and ergonomically designed for easy use. The standard model includes two independent three-position switches which are actuated by squeezing the trigger. Additional models are available with an optional jog button or dual channel e-stop button.

The trigger switch has three positions. The mid-position is the “enabled” position.

Position 1—there is no pressure on the trigger switch, and the safety contacts are open.

Position 2—the trigger switch is squeezed to the mid-position, and the safety contacts are closed. This mid-position is the “enabled” position.

Position 3—the trigger switch is fully pressed and the safety contacts are open.

When the trigger switch is released from position three back to position one, the safety contacts remain open, as it passes through position two.

### Features

- Dual three position enabling switches
- Lightweight and ergonomic
- Optional jog and e-stop functions

### Specifications

Safety Ratings				
Standards		IEC/EN60947-5-8, IEC/EN 60947-5-1, IEC/EN 60204-1, NFPA 79, ANSI B11.19, ANSIR15.06, ISO 10218, ISO 11161		
Safety Classification		Cat. 1 Device per EN954-1; Dual Channel Suitable for Cat. 3 or 4 Systems		
Certifications		CE marked for all applicable directives, cULus, BG		
Outputs				
Safety Contacts *		2 N.C. Direct-Opening Action		
Auxiliary Contacts		1 N.C.		
Jog Contact		1 N.O.		
E-Stop		2 N.C. Direct-Opening Action		
Thermal Current $I_{th}$		3 A		
Rated Insulation Voltage		(Ui) 250V (Jog Button 125V)		
Switching Current @ Voltage, Min.		5 mA @ 3V AC/DC		
Utilization Category		30V DC	125V AC	250V AC
3-Position Switch Terminals 1-2 and 3-4	DC-12 or AC-12 Resistive	2 A	3 A	0.5 A
	DC-13 or AC-15 Inductive	1 A	1.5 A	0.5 A
Monitor Switch Terminals 5-6	DC-12 or AC-12 Resistive	2 A	2 A	1 A
	DC-13 or AC-15 Inductive	1 A	1 A	0.5 A
E-Stop Switch Terminals 5-6 and 7-8	DC-12 or AC-12 Resistive			
	DC-13 or AC-15 Inductive			0.5 A
Operating Characteristics				
Operating Force, Min.		Position 2: 15 N approx. Position 3: 50 N max.		
Direct Opening Force		90 N (20 lbs)		
Actuation Frequency, Max.		1200 operations per hour		
Environmental				
Enclosure Type Rating		IP 66 Standard Switch (NEMA 6) IP 65 Jog Button and E-Stop Switches		
Relative Humidity		45...85%		
Operating Temperature—C (F)		-10...+60° (14...140°)		
Vibration		5...55 Hz, 0.5 mm		
Shock		10 g		
Physical Characteristics				
Wire Size		0.14...1.5 mm <sup>2</sup> (24...14 AWG)		
Cable Size		7...13 mm (0.27... 0.51 in)		
Terminal Screw Torque		0.5...0.6 N•m (4.4...5.3 ib •in)		
Conduit Type		M20		
Material		Polyamide (Nylon) PA66		
Boot Material		NBR/PVC Nitrile Blended with PVC		
Weight—g (lbs)		250 (0.55) with E-Stop 210 (0.46) Standard and Jog		
Color		Black/Grey		

\* The safety contacts are described as normally closed (N.C.) i.e., with the guard closed, actuator in place (where relevant) and the machine able to be started.

## Product Selection

Description	Cat. No.			
	Conduit	Connectors*		
	M20 Conduit with Cable Strain Relief	4-Pin M12 Micro Quick Disconnect*	5-Pin M12 Micro Quick Disconnect*	8-Pin M12 Micro Quick Disconnect
Standard Switch (No additional buttons)	440J-N21TNPM	440J-N2NTNPC	440J-N2NTNPS	—
Switch with Jog Button	440J-N21TNPM-NP	—	—	440J-N21TNPH-NP
Switch with Emergency Stop Button	440J-N2NTNPM-NE	—	—	440J-N2NTNPH-NE

\* For connector ratings see page 3-9.

\* With 4- and 5-pin M12 connectors, the auxiliary contact is not connected.

**Note:** Base plate included with all switches.

## Recommended Logic Interfaces

Description	Safety Outputs	Auxiliary Outputs	Terminals	Reset Type	Power Supply	Cat. Page No.	Cat. No.
<b>Single-Function Safety Relays for 2 N.C. Contact Switch</b>							
MSR127RP	3 N.O.	1 N.C.	Removable (Screw)	Monitored Manual	24V AC/DC	5-24	440R-N23135
MSR127TP	3 N.O.	1 N.C.	Removable (Screw)	Auto./Manual	24V AC/DC	5-24	440R-N23132
<b>Modular Safety Relays</b>							
MSR210P Base 2 N.C. only	2 N.O.	1 N.C. and 2 PNP Solid State	Removable	Auto./Manual or Monitored Manual	24V DC from the base unit	5-74	440R-H23176
MSR220P Input Module	—	—	Removable	—	24V DC	5-78	440R-H23178
MSR310P Base	MSR300 Series Output Modules	3 PNP Solid State	Removable	Auto./Manual Monitored Manual	24V DC	5-94	440R-W23219
MSR320P Input Module	—	2 PNP Solid State	Removable	—	24V DC from the base unit	5-98	440R-W23218

**Note:** For additional Safety Relays connectivity, see the Safety Relays section (page 5-8) of this catalog.

For additional Safety I/O and Safety PLC connectivity, see the Programmable Safety System section (page 5-107) of this catalog.

For application and wiring diagrams, see the Safety Applications section (page 10-1) of this catalog.

## Connection Systems

Description	Cat. No.		
	4-Pin Micro (M12) Quick Disconnect	5-Pin Micro (M12) Quick Disconnect†	8-Pin Micro (M12) Quick Disconnect
Cordset	889D-F4AC-♣	889D-F5AC-♣	889D-F8AB-♣
Patchcord	889D-F4ACDM-§	889D-F5ACDM-§	889D-F8ABDM-§







♣ Replace symbol with 2 (2 m), 5 (5 m), or 10 (10 m) for standard cable lengths.

§ Replace symbol with 1 (1 m), 2 (2 m), 5 (5 m), or 10 (10 m) for standard cable lengths.

† To connect to ArmorBlock Guard I/O.

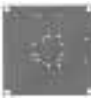
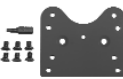
4-Emergency Stop Devices

Accessories

	Description	Cat. No.
	Mounting bracket suitable for single enabling switch*	440J-A00N
	Mounting bracket suitable for one actuator mounted onto switch* Includes four flat head screws and one resistorx bit.	440J-A01N
	Mounting bracket suitable for single enabling switch and single safety switch*	440J-A02N
	Mounting bracket suitable for two actuators mounted onto switch* Includes six flat head screws and one resistorx bit.	440J-A03N
	Mounting bracket suitable for single enabling switch and two safety switches*	440J-A04N
	Set of ten flat head M5 x 0.8-8H long screws	440J-A05N
	Cable strain relief	440J-A06N
	NBR/PVC (silicone free) rubber boot kit	440J-A10N

\* The bracket has predrilled holes suitable for mounting either the MT-GD2, Trojan 5, or Trojan 6. Please note that the enabling switch, safety switch, and actuator are not supplied with the mounting bracket and are available separately.

**Approximate Dimensions—mm (inches)**

Dimensions are not intended to be used for installation purposes.

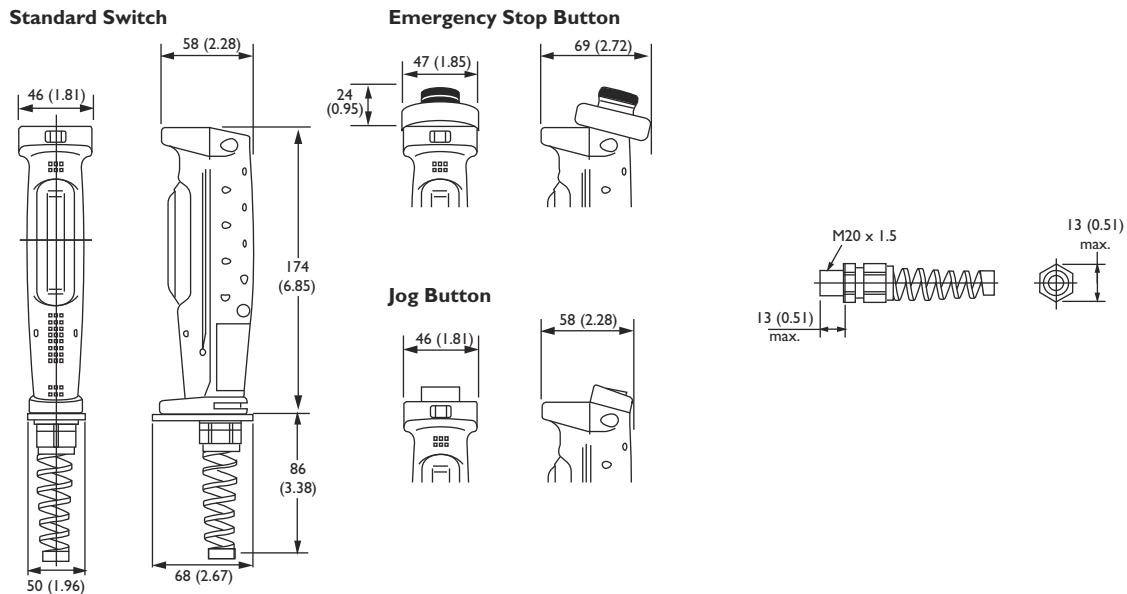

A range of brackets are available to allow the enabling switch to be mounted alone, or with one or two safety switches. A small bracket has already been fitted to the enabling switch onto which the actuator bracket is mounted. An Application Note on the use of the enabling switch in conjunction with a safety switch is available.

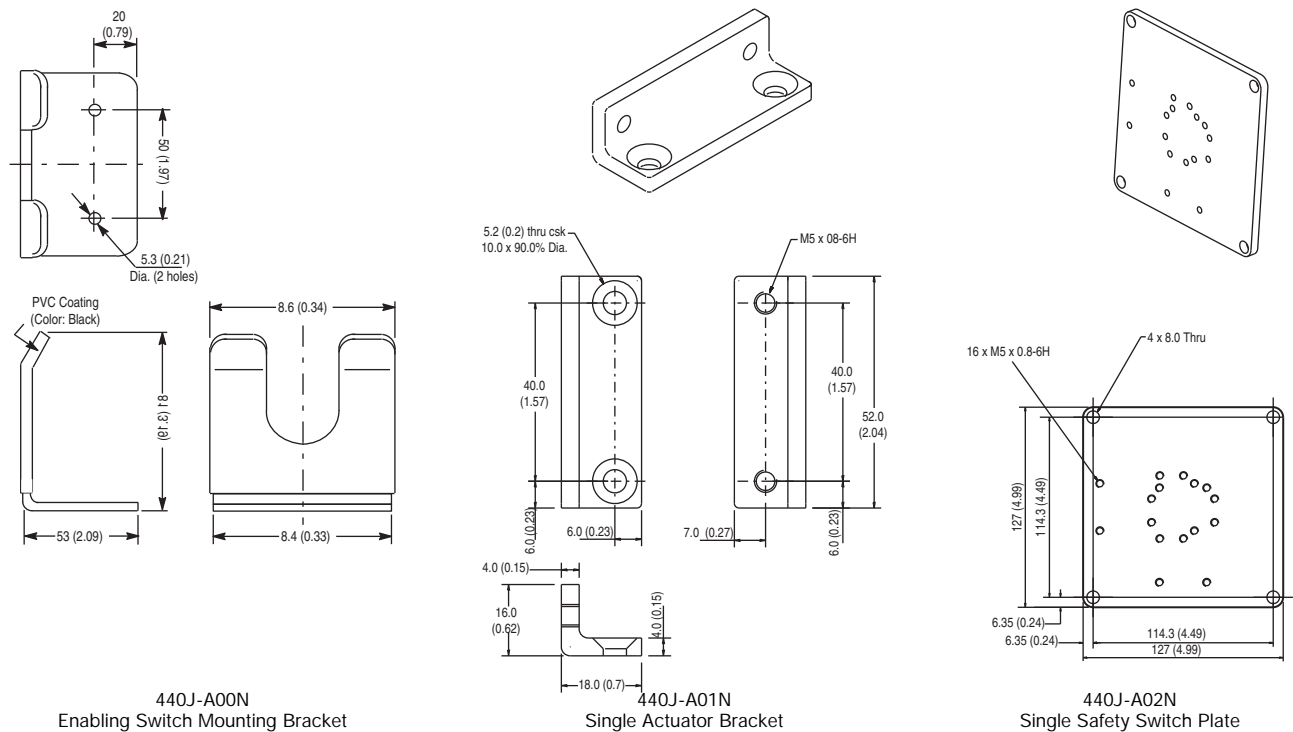

4-Emergency Stop Devices



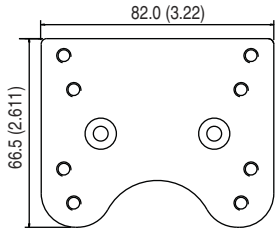
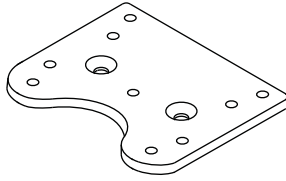

440J-A03N  
 Double Actuator Plate

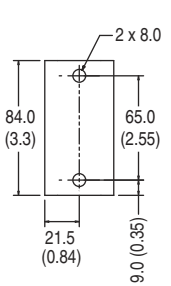
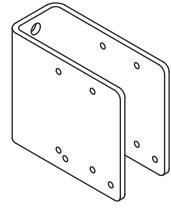

440J-A04N  
 Double Safety Switch Bracket

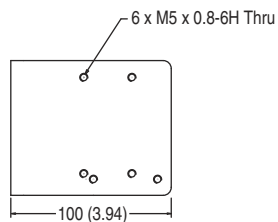
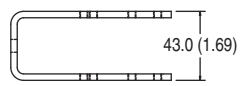

Typical Wiring Diagram

	Standard	With Jog Button	With E-Stop Button	
Contact Operation				
Cable Termination				
Quick Disconnect Termination				
Mating Cordsets	<p>889D-F4AC-*</p> <p>1 Brown Safety A                  2 White</p>	<p>889D-F5AC-*</p> <p>1 Brown Safety A                  2 White                  3 Blue NA                  4 Black Safety B                  5 Grey</p>	<p>889D-F8AB-*</p> <p>1 White Safety A                  2 Brown                  3 Green Safety B                  4 Yellow                  5 Grey Aux                  6 Pink                  7 Blue Jog                  8 Red</p>	<p>889D-F8AB-*</p> <p>1 White Safety A                  2 Brown                  3 Green Safety B                  4 Yellow                  5 Grey E-Stop A                  6 Pink                  7 Blue E-Stop B                  8 Red</p>

4-Emergency Stop Devices



**Specifications — 22.5 mm\***  
**Front-of-Panel (Operators)**

Description		Mechanical Ratings	
		Plastic (Bulletin 800FP)	Metal (Bulletin 800FM)
Vibration (assembled to panel)		Tested at 10...2000 Hz, 1.52 mm displacement (peak-to-peak) max./10 G max. for 3 hr duration, no damage	
Shock		Tested at 1/2 cycle sine wave for 11 ms; no damage at 100 G	
Degree of protection*		IP65/66 (Type 3/3R/4/4X/12/13)	IP65/66 (Type 3/3R/4/12/13)
Mechanical durability per EN 60947-5-1 (Annex C)	10 000 000 Cycles	Momentary Push Buttons, Momentary Mushroom	
	1 000 000 Cycles	Multi-Function, Selector Switch, Key Selector Switch, Selector Jog, SensEject™ Key Selector Switch	
	500 000 Cycles	Non-Illuminated Push-Pull E-Stop	
	300 000 Cycles	Twist-to-Release E-Stop, Illuminated Push-Pull E-Stop, Alternate Action Push Buttons	
	100 000 Cycles	Potentiometer, Toggle Switch	
Operating forces (typical with one contact block)		Flush/extended = 5 N, E-stop = 36 N Mushroom = 9 N	
Operating torque (typical application with one contact block)		Selector switch = 0.25 N•m (2.2 lb-in.)	
Mounting torque	Plastic	1.7 N•m (15 lb-in.)	
	Metal	4.4 N•m (40 lb-in.)	
Environmental			
Temperature range (operating)		-25...+70°C (-13...158°F)‡	
Temperature range (short term storage)		-40...+85°C (-40...185°F)	
Humidity		50...95% RH from 25...60°C (77...140°F)	

\* Performance Data — see page Important-2 of the *Industrial Controls* catalog.

\* Momentary mushroom operators are IP65. Plastic keyed operators are IP66, Type 4/13; not Type 4X.

‡ Operating temperatures below 0°C (32°F) are based on the absence of freezing moisture and liquids, UL recognized to 55°C (131°F) - Incandescent module Max 40°C (104°F).

**Product Certifications**

Certifications	UR/UL, CSA, CCC, CE
Conformity to Standards — CE marked	NEMA ICS-5; UL 508, EN ISO 13850, EN 60947-1, EN 60947-5-1, EN 60947-5-4, EN 60947-5-5
Terminal Identification	IEC 60947-1
Shipping Approvals	ABS
RoHS	✓

4-Emergency Stop Devices

Operator Interface  
**Push Buttons**  
 800F 22.5 mm

Back-of-Panel Components

Electrical Ratings			
Standard contact block ratings		A600, Q600 600V AC AC 15, DC 13 to IEC/EN 60947-5-1 and UL 508, 17V, 5 mA min.	
Low voltage contact block ratings*		5V, 1 mA DC min. C300, R150, AC 15, DC 13 to EN 60947-5-1 and UL 508	
Nominal Voltage		Range	Current Draw [mA]
LED Module Ratings	24V AC	10...29V AC	31
	24V DC	10...30V DC	24
	120V AC	70...132V AC	25
	240V AC	180...264V AC	22
Frequency		50/60 Hz DC 50/60 Hz 50/60 Hz	
Thermal current		10 A max. enclosed (40°C ambient) to UL508, EN 60947-5-1	
Insulation voltage (Ui)		Screw terminal = 690V, spring-clamp = 300V	
Wire capacity (screw terminal)†		#18...12 AWG (0.75...2.5 mm <sup>2</sup> ) Max. (2) #14 AWG or (1) #12 AWG	
Wire capacity (spring-clamp terminal)		#18...14 AWG (0.75...1.5 mm <sup>2</sup> )	
Recommended tightening torque on screw terminals		0.7...0.9 N•m (6...8 lb-in.)	
Dielectric strength (minimum)		2500V for one minute	
External short circuit protection	Standard blocks	10 A type gL/gG cartridge fuse to EN 60269-2-1 or gN (Class J to UL 248-8 or Class C to UL 248-4)	
	Low voltage contact blocks	6 A type gL/gG cartridge fuse to EN 60269-2-1 or gN (Class J to UL 248-8 or Class C to UL 248-4)	
Electrical shock protection		Finger-safe conforming to IP2X	
Mechanical Ratings			
Vibration (assembled to panel)		Tested at 10...2000 Hz, 1.52 mm displacement (peak-to-peak) max./10 G max. 6 hr	
Shock		Tested at 1/2 cycle sine wave for 11 ms and no damage at 100 G max.	
Contact durability per EN 60947-5-1 (Annex C)		10,000,000 cycles	
Contact operation	N.O.	Slow double make and break	
	N.C.	Slow double make and break — positive opening ⊖	
	N.O.E.M.	Double break / double make, early make	
	N.C.L.B.	Double break / double make, late break — positive opening ⊖	
	N.C.E.B.	Double break / double make, early break — positive opening ⊖	
Push button travel to change electrical state	N.C. and N.O.E.M.	1.5 mm (0.060 in.)	
	N.O. and N.C.L.B.	2.5 mm (0.1 in.)	
Operating forces (typical)	Single circuit contact block	3.4 N	
	Dual circuit contact block	5...6.5 N	
Illumination			
LED Dominant Wavelength	Green	525 nm	
	Red	629 nm	
	Yellow	590 nm	
	Blue	470 nm	
	White	—	
LED Luminous Intensity	Green	780 mcd	
	Red	780 mcd	
	Yellow	600 mcd	
	Blue	168 mcd	
	White	360 mcd	
Incandescent maximum wattage		2.6 W	
Materials			
Springs		Stainless steel and zinc coated music wire	
Electrical contacts	Standard	Silver-nickel	
	Low voltage	Gold-plated over silver	
Terminals	Screw	Brass	
	Spring-clamp	Silver-plated brass	

\* Performance Data — see page Important-2 of the *Industrial Controls* catalog.

\* Low voltage contacts are recommended for applications below 17V, 5 mA.

† Wires less than #18 may not hold in terminal securely.

## Material Listing

Component	For Use with	Material Used
Panel gasket	All operators	Nitrile, TPE
Diaphragm seal	Illuminated push button, non-illuminated push button	Automotive industry acceptable silicone
K-seal	Selector switch, key selector switch, push/twist-to-release E-stop, key E-stop, push/pull mushroom	Nitrile
Diaphragm retainer, return spring I	Illuminated push button, non-illuminated push button, momentary mushroom	Stainless steel
Return spring II	Reset, selector switch, key selector switch, alternate action, push/twist-to-release E-stop, key E-stop, push/pull mushroom	Zinc-coated music wire
Button cap/mushroom head	Non-illuminated push button, momentary mushroom, reset, push/twist-to-release E-stop, key E-stop, push/pull mushroom, multi-function	PBT/polycarbonate blend
2-color molded button cap	Non-illuminated push button	PBT/polycarbonate blend
Lens	Multi-function	Acetal
Lens, knob	Illuminated push button, illuminated momentary mushroom, illuminated selector switch	Polyamide
Knob	Non-illuminated selector switch	Glass-filled polyamide
Plastic bezel/bushing I	Non-illuminated push button, illuminated push button, momentary mushroom, selector switch, key selector switch, push/twist-to-release E-stop, key E-stop, push/pull mushroom, multi-function, reset	Glass-filled polyamide
Plastic bezel/bushing II, jam nut	Pilot light, reset jam nut, reset pushers	Glass-filled PBT
Metal bezel/bushing	All metal operators	Zinc
Diffuser	Illuminated push button, pilot light	Polycarbonate
Legend frames	—	Glass-filled polyamide
Plastic mounting ring	All plastic operators	Glass-filled polyamide
Metal mounting ring	All metal operators	Chromated zinc
Plastic latch	—	Glass-filled polyamide
Metal latch	—	Chromated zinc + stainless steel
Plastic enclosure	—	PBT/polycarbonate blend
Metal enclosure	—	Aluminum
Terminal screws	LED module, incandescent module, contact blocks	Zinc-plated steel with chromate
Terminals	LED module, incandescent module, contact blocks	Brass with silver-nickel contacts
Spring clamps	LED module, incandescent module, contact blocks	Stainless steel
Lamp socket	Incandescent module	Brass
Housing	Incandescent module, LED module	Glass-filled polyamide
Low-voltage terminals	Contact blocks	Gold-plated silver-nickel contacts
Low-voltage spanner	Contact blocks	Gold-plated silver-nickel contacts
Spanner	Contact blocks	Brass with silver-nickel contacts
Boot	Toggle Switch, illuminated push button, non-illuminated push button, multi-function illuminated and non-illuminated	Automotive industry acceptable silicone