

GridScan/Pro SI

Installation and Operation Manual

EN 12453
E device



EN 13849-1

CEDES AG is certified according to ISO 9001: 2015

English

Pages

1 – 23

Original version

Contents

1.	About this manual	2
1.1	Measurements	2
1.2	Related documents	2
1.3	CEDES headquarters	2
1.4	Certification Body	2
2.	Safety information	3
2.1	Non-intended use	3
3.	Symbols, safety messages	3
3.1	Safety messages categories	3
4.	Introduction	4
4.1	Features of the GridScan/Pro SI	4
4.2	GridScan/Pro SI modes	4
4.3	Type description	4
4.4	Intended use	4
5.	Overview	5
5.1	Delivery package	5
5.2	General instructions and precautions	5
5.3	Alignment	6
6.	Application overview	6
6.1	Door blanking	7
7.	Installation	7
8.	Electrical connection	9
9.	RS485 protocol	9
9.1	General communication specifications	9
9.2	RS485 communication protocol	10
10.	Guidelines for implementation (RS485)	15
10.1	Functions of GridScan/Pro SI	15
10.2	Safety function RS485 CEDES communication protocol	16
10.3	Implementation of RS485 CEDES communication protocol (RC)	17
10.4	Change of operation mode (blanking into static mode)	18
11.	System timing (RS485)	19
12.	Start-up	20
13.	LED status description	20
14.	Troubleshooting	21
15.	Maintenance	21
16.	Disposal	21
17.	Technical data	22
18.	Dimensions	23

1. About this manual

2	This installation and operation manual in English, with metric and inches measurements is the original version .
2	The version number is printed at the bottom of each page.
2	To make sure you have the latest version, visit www.cedes.com where this manual and related documents can be downloaded.
3	
3	
3	1.1 Measurements
3	Measurements are, if not stated otherwise, given in mm (non-bracketed numbers) and inches (numbers in brackets).
4	
4	1.2 Related documents
4	GridScan/Pro SI datasheet 001 250 en
5	GridScan/Pro SI Installation guide 116 680
5	
6	1.3 CEDES headquarters
7	CEDES AG Science Park CH-7302 Landquart Switzerland
7	
9	1.4 Certification Body
9	TÜV NORD CERT GmbH
10	Langemarckstr. 20 DE-45141 Essen Germany
15	
15	
16	
17	
18	
19	
20	
20	
21	
21	
21	
22	
23	

2. Safety information

**IMPORTANT
READ BEFORE INSTALLATION!**

The GridScan/Pro SI was developed and manufactured using state-of-the-art systems and technologies. However, injury and damage to the sensor can still occur.

To ensure safe conditions:

- ▶ Read all enclosed instructions and information.
- ▶ Follow the instructions given in this manual carefully.
- ▶ Observe all warnings included in the documentation and attached to the sensor.
- ▶ Do not use the sensor if it is damaged in any way.
- ▶ Keep the instruction manual on site.

The GridScan/Pro SI should only be installed by authorized and fully trained personnel! The installer or system integrator is fully responsible for the safe integration of the sensor. It is the sole responsibility of the planner and/or installer and/or buyer to ensure that this product is used according to all applicable standards, laws and regulations in order to ensure safe operation of the whole application.

Any alterations to the device by the buyer, installer or user may result in unsafe operating conditions. CEDES is not responsible for any liability or warranty claim that results from such manipulation.

Failure to follow instructions given in this manual and/or other documents related to the GridScan/Pro SI may cause customer complaints, serious call backs, damage, injury or death.

2.1 Non-intended use

The GridScan/Pro SI **must not** be used for:

- Protection of dangerous machine
- Equipment in explosive atmospheres
- Equipment in radioactive environments



Use only specific and approved safety devices for such applications, otherwise serious injury or death or damage to property may occur!

3. Symbols, safety messages

Symbol	Meaning
▶	Single instruction or measures in no particular order
1.	Sequenced instructions
2.	
3.	
•	List, in no order of importance
→	Reference to a chapter, illustration or table within this document
Important	Important information for the correct use of the sensor

3.1 Safety messages categories

Warning of serious health risks

WARNING
Serious health risks

Highlights critical information for the safe use of the sensor. Disregarding these warnings can result in serious injury or death.

- ▶ Follow the measures highlighted by the triangle-shaped arrows
- ▶ Consult the safety information in Chapter 2 of this manual

Caution of possible health risk

CAUTION
Possible health risks

Highlights critical information for the safe use of the sensor. Disregarding these warnings can result in injury.

- ▶ Follow the measures highlighted by the triangle-shaped arrows
- ▶ Consult the safety information in Chapter 2 of this manual

Notice of damage risk

NOTICE
Risk of damage

Disregarding these notices can lead to damage to the sensor, the door controller and/or other devices.

- ▶ Follow the measures highlighted by the triangle-shaped arrows

4. Introduction

The GridScan/Pro SI is a very reliable SIL 2 certified safety light curtain. It was developed and designed to safeguard all types of industrial doors, such as sectional or high-speed doors. The system is ideal for door openings up to 10 m wide and can handle door closure speed of 1.6 m/s. The opening speed is up to 3 m/s. The emitter and receiver can be installed directly into the guide rail (blinking mode) or to the front or the back of the door (static mode). Therefore, both modes are useable in one system and can be changed after a power-up.

In the GridScan/Pro SI, a serial interface is used to communicate with the door control unit. Due to this interface, the system allows the system integrator to implement intelligent functions like soft stop to reduce the mechanical wear or a plausibility check of the door position. In addition, single beam and maintenance information are available.



Figure 1: Typical GridScan/Pro SI application environments

4.1 Features of the GridScan/Pro SI

- TÜV – EC Type examination certified
- SIL 2 certified
- Direct integration into the door edge due to door blanking
- Serial interface with single beam information
- Changeable operation between blanking and static mode
- Easiest alignment
- Door closing speed up to 1.6 m/s

4.2 GridScan/Pro SI modes

• Delivery mode - blanking

The delivery mode features door blanking and resolution, according to EN 12978:2009. This means there are different resolutions between elements along the length of the edge.

• Selectable mode - static

The selectable mode has no door blanking feature. It can be used as a Cat. 2 safety light curtain for different applications (Chapter 9).

Important: The GridScan/Pro SI system is certified according to EN ISO 13849-1:2015 and EN 12978:2009 if the door is monitored over its full height up to 2.5 m (8.2 ft).

4.3 Type description

GRS/Pro – aa – bbbb – cc, dd

aa	:	SY	System
		Tx	Emitter
		Rx	Receiver
bbbb	:	Safety length in mm	
cc	:	Number of elements	
dd	:	Information of interface protocol	

Figure 2: Type description

Example:

- GRS/Pro SY-2500-22, RC
GridScan/Pro SI system, 2500 mm safety length, 22 elements, with CEDES specific RS485 interface

4.4 Intended use

The GridScan/Pro SI is designed and approved for the mounting and use in- (blinking mode) and outside (static mode) guiding rails of industrial doors to protect persons according to EN 12978:2009 and EN 12453:2017.

The GridScan/Pro SI can be used as a safety device according EN 12453:2017 as E-device and fulfills the safety levels up to SIL 2 according to EN 61508:2010 and the category 2 (cat. 2) / performance level d (PL d) according to EN ISO 13849-1:2015.

The serial interface is developed according to the safety communication standard EN 61784-3:2017 and delivers a safe communication to the door control unit.

5. Overview

The emitter and receiver edges create a grid of infrared beams offering up to 2.5 m (8.2 ft) in protection height. When the infrared beams are interrupted, the output (communicated by the protocol as **State of light curtain**) sends a signal to the connected door control unit. As soon as the detection area is clear again, the output switches to indicate that the area is "clear". The blanking system (blanking mode, Chapter 4.2) is designed to mount directly into the guide rails. As the door closes, the GridScan/Pro SI recognizes the door as such and does not switch the output.



Figure 3: Sectional doors with door blanking

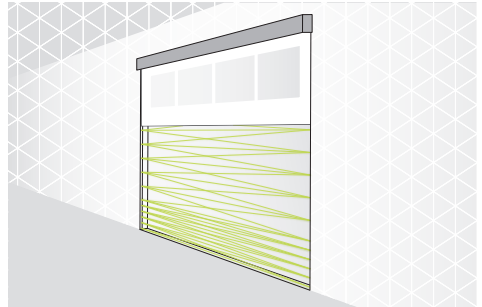

Figure 4: High-speed doors with door blanking

5.1 Delivery package

The GridScan/Pro SI package comprises:

- 1 × GridScan/Pro SI emitter edge (Tx)
- 1 × GridScan/Pro SI receiver edge (Rx)
- 1 × Synchronization cable 10 m (33 ft)
- 1 × Connection cable 5 m (16.5 ft)
- 1 × Installation guide

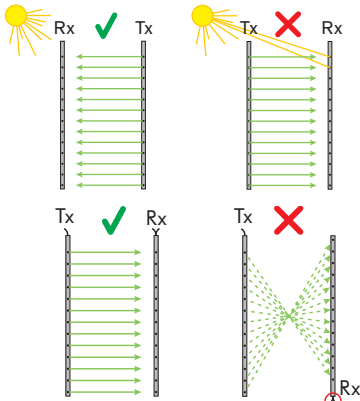

Figure 5: Typical GridScan/Pro SI delivery package

5.2 General instructions and precautions



- ▶ Never scratch or paint the optical lenses because they form the light path! Do not drill additional holes into the profile. Unpack the profiles just before installation in order to avoid damage.
- ▶ Do not bend or twist the edges!
- ▶ Oil can damage the cables. Contamination must be avoided at all times!
- ▶ Chemicals can damage the profile and optical characteristics. Contact must be avoided at all times!



- ▶ Although the GridScan/Pro SI is insensitive to direct sunlight, avoid all unnecessary exposure if possible, most especially to the receiver.
- ▶ Avoid interference from blinking lights or infrared light sources such as photo cells or other light curtains.
- ▶ Do not install the GridScan/Pro SI in places where the emitter and receiver edges are directly exposed to light sources such as FL tubes or energy saving lamps.
- ▶ Make sure to place the connection plugs for both the emitter and receiver at the same end.

CAUTION
Damage to the eye

Although the GridScan/Pro SI does not emit dangerous amounts of infrared light, long exposure to intense infrared light sources can result in damage to the eyes.

- ▶ Never look directly into the active infrared emitter from a close distance.

5.3 Alignment

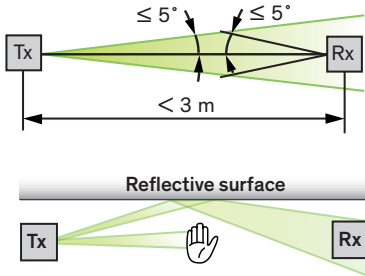

The optical axis of the emitter (Tx) and the receiver edge (Rx) need to be aligned towards each other to ensure the light curtain functions reliably.

Reflective surfaces near to or parallel to the safeguarded area can cause reflections and interfere with the GridScan/Pro SI's functions. Keep a reasonable distance between the sensor edges and any reflective surface.

A self-calibration on each optical beam is implemented. At the power-up the ideal emitting strength will be detected and used. To reduce interruption caused by dust the system checks the emitting power and adapts a new higher or lower strength if necessary.

6. Application overview

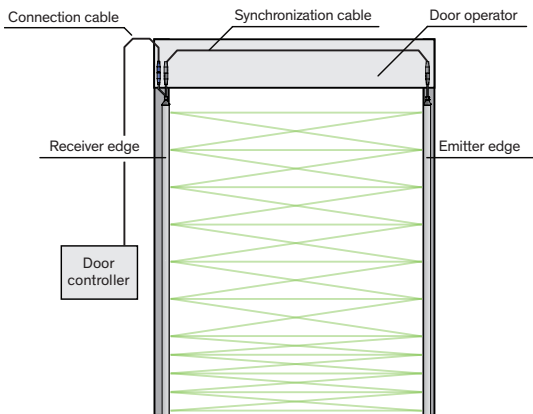

Figure 6: GridScan/Pro SI application (overview)

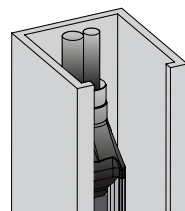

Figure 7: GridScan/Pro SI with door blanking (blanking mode)

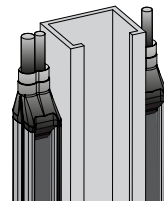

Figure 8: GridScan/Pro SI statically mounted (static mode)

6.1 Door blanking

The GridScan/Pro SI can differentiate between a light beam interruption caused by an object and a light beam interruption caused by the closing door. The GridScan/Pro SI does this by analyzing the different interruption patterns.

Closing door interruption pattern:

The light beam interruption of a closing door starts at the topmost beam going downwards. There are two ways to achieve blanking:

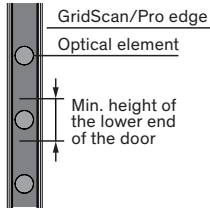

Figure 9.1 Door blanking through door edge

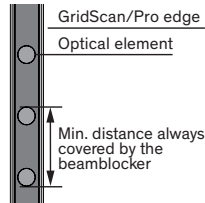

Figure 9.2 Door blanking through beam blocker

When the GridScan/Pro SI is integrated into the guide rail, the door moves directly in front of the light curtain. This means the lowest section of the door needs to be at least 30 mm in height to ensure that at least one element is completely covered. It is also essential that the door's leading edge extends the full distance between the light curtain's emitter and receiver (Figure 9.1).

If the light curtain is located either in front of or behind the guide rail, the descending door will not interrupt the active beams. However, blanking may still be required if any part of the door (e.g. cable) interrupts the light curtain. A beam blocker can be used, but it must be mounted so that at least one element is continuously covered during door closure (Figure 9.2).

7. Installation



WARNING Electrical and mechanical hazards

- Electrical shock and unexpected door movement can cause serious injury or death.
- ▶ Follow all applicable safety measures.
 - ▶ Use only specific and approved tools.
 - ▶ If the GridScan/Pro SI has to be adjusted, the main power supply must be switched off and marked as out of service.

NOTICE

Mechanical damage to the GridScan/Pro SI

- ▶ Do not drill additional holes into the light curtain.
- ▶ Do not overtighten the mounting screws.
- ▶ Mount the edges on a flat surface.

Important:



- Switch off main power to the door control unit and mark clearly that this system is out of service before performing any work on the system.
- Mount the receiver edge into the guiding rail next to the door control unit.

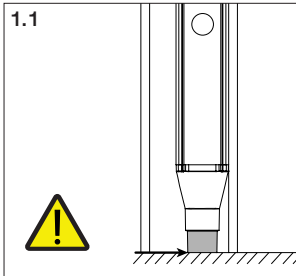

1.1 Receiver and emitter must be mounted at the same height.

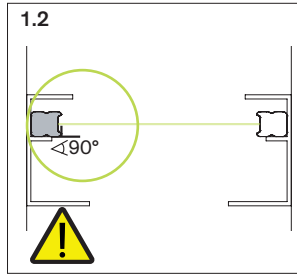

1.2 Check the alignment of the edges. The receiver must be mounted 180° to the emitter.

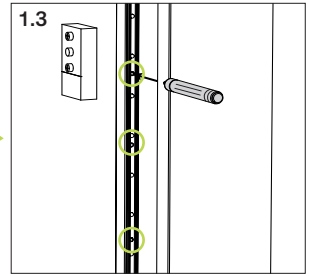

1.3 Mark the mounting hole on the mounting guide.

Important for the blanking mode:

- ▶ Mount the receiver edge into the guiding rail next to the door control unit (Figure 7).
- ▶ In order to fulfill EN 12978:2009 the lower end of the edges has to be at the level of the door closed position.

Important:

Make sure the optical elements are facing each other (Chapter 5.3).

Important for the static mode:

When the GridScan/Pro SI is statically mounted (Figure 8) the door must not interrupt the beams (no door blanking).

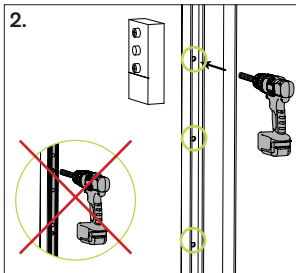

2. Drill the holes for mounting at the marked position (mounting holes of the edge are \varnothing 4.3 mm).

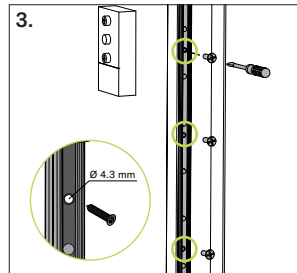

3. Mount the edge with screws from the front side into the drill holes.

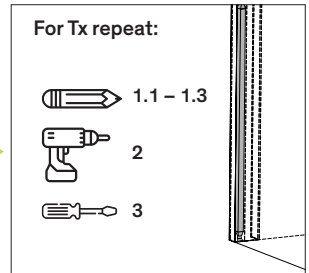

Mount the emitter edge opposite the receiver edge. If the receiver is mounted in the guiding rail, the emitter should be mounted opposite the receiver in the guiding rail.

Important:

Do not drill through the mounting holes of the edges.

Important:

Make sure the optical elements are facing each other (Chapter 5.3).

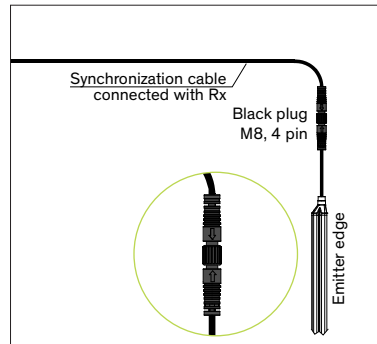
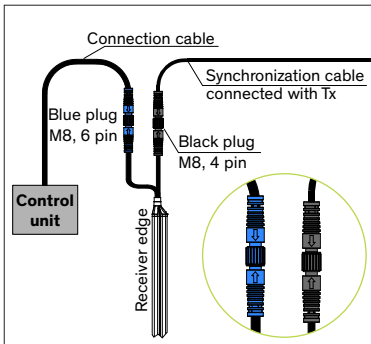

1. Connect the synchronization cable (black plug) to the receiver edge and guide the cable to the emitter side.
2. Connect the connection cable (blue plug) to the receiver edge and guide the cable to the door control unit.

Connect the synchronization cable (black plug) to the emitter edge.

8. Electrical connection

The GridScan/Pro SI has only a serial interface for the communication. No physical Push-Pull or OSE output is available. The functionality of test input or output is implemented in the communication protocol.

For a safe installation, the light curtain needs to be installed, activated and tested according to the door control unit guideline.

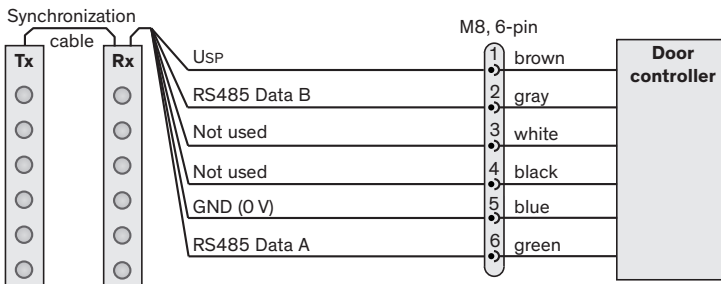

Figure 10: Connection diagram for serial interface RS485

Important: Any unconnected (not used) wire must be separated and isolated.

9. RS485 protocol

9.1 General communication specifications

- The data rate is fixed at 115.2 kbps.
- Least significant byte is transmitted first, most significant byte is last.
- One start bit
- 8 data bits
- No parity bit
- One stop bit
- Half duplex, Point-to-Point communication

9.2 RS485 communication protocol

The protocol has maximum 20 bytes and is sent in one message in the little endian order:

Byte 0 -3	Byte 4	Byte 5	Byte 6-n	Byte n+1-n+4
Sync pattern	SeqCnt	ID	Payload	CRC-32

9.2.1 Sync pattern

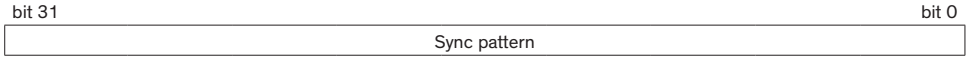

bit 0-31 Sync pattern (unsigned 32 bit):
 In front of a transmitted package, a synchronization pattern is sent. This pattern is not safety-relevant and therefore not used for the CRC calculation. The synchronization pattern is fixed on the value 0x454444543.

9.2.2 SeqCnt (safety relevant)



bit 0-31 SeqCnt (unsigned 8 bit):
 The sequence counter has to increase by one in every message. It starts at 0 and rolls over from 255 back to 0. In an active streaming mode, a separate SeqCnt value is used.

Example:

First request	Counter value:	12
Answer of first request	Counter value:	13
2nd request	Counter value:	14
...		

9.2.3 ID

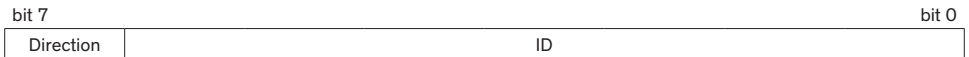

bit 0-6 ID (unsigned 8 bit):
 The ID values are used for commands sent by the control unit.

ID	Command
0x10	Mode: Set polling
0x11	Mode: Set full streaming
0x12	Mode: Set reduced streaming
0x13	Mode: Set stand-by
0x14	Mode: Get current
0x20	Info: Get version
0x21	Info: Get product information
0x22	Info: Get count of elements
0x23	Info: Communication test
0x24	Info: Get alignment value
0x25	Info: Request alignment mode
0x30	Data: Reduced state
0x31	Data: Full state
0x40	Safety: Test input
0x50	Config: Allow change
0x51	Config: Set static
0x52	Config: Set blanking
0x53	Config: Get current

bit 7 Direction bit
 This bit defines the direction from the transmitted message.
 0: Control unit to GridScan/Pro SI
 1: GridScan/Pro SI to control unit

9.2.4 Payload

The payload has a maximum length of 10 bytes. The length is defined by the requested command ID. All request packages have no payload. Hereafter, the payload of the response package is defined.

Mode: Set polling

No data exist. The light curtain switches to the requested mode.

Mode: Set full streaming

No data exist. The light curtain switches to the requested mode.

Mode: Set reduced streaming

No data exist. The light curtain switches to the requested mode.

Mode: Set stand-by

No data exist. The light curtain switches to the requested mode.

Mode: Get current

bit 7	Reserved	bit 0
Reserved		Current mode

- bit 0-1 **Current mode (signed 2 bit):**
- 0 = Polling mode
 - 1 = Full streaming mode
 - 2 = Reduced streaming mode
 - 3 = Stand-by mode

bit 2-7 **Reserved:**
Reserved values, values not defined (mask out).

Info: Get version

bit 79	HW Version	bit 0
HW Version		SW Version

bit 0-39 **SW Version (40 bit, ASCII encoded string):**
xx.yy = Hardware version with two digits in front and after a point.

bit 40-79 **HW Version (40 bit, ASCII encoded string):**
xx.yy = Software version with two digits in front and after a point.

Info: Get product information

bit 79	Number of elements	Reserved	bit 0
Number of elements		Reserved	CEDES part number

bit 0-47 **CEDES part number (48 bit, ASCII encoded string):**
xxxxxx = CEDES part number of the receiver edge without space
Example: 116xxx corresponds with label part number 116 xxx

bit 48-71 **Reserved:**
Reserved values, values not defined (mask out).

- bit 72-79 **Number of elements (signed 8 bit):**
- 12 = Light curtain with 12 elements
 - 13 = Light curtain with 13 elements
 - 14 = Light curtain with 14 elements
 - ...
 - 60 = Light curtain with 60 elements

Info: Get count of elements

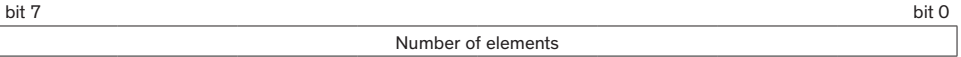

- bit 0-7 **Number of elements (signed 8 bit):**
- 12 = Light curtain with 12 elements
- 13 = Light curtain with 13 elements
- 14 = Light curtain with 14 elements
- ... =
- 60 = Light curtain with 60 elements

Info: Communication test



- bit 0 **CRC:**
Bit is set if CRC is not correct.
- bit 1 **SeqCnt :**
Bit is set if the sequence counter is not correct.
- bit 2 **Sync pattern:**
Bit is set if the synchronization pattern is not correct.
- bit 3-7 **Reserved:**
Reserved values, values not defined (mask out).

Info: Get alignment value

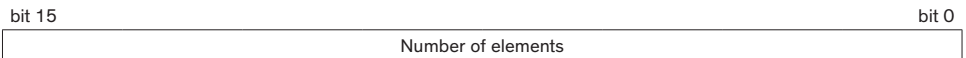

- bit 0-15 **Alignment value (signed 16 bit):**
Value between 0 – 65535, best alignment at the lowest possible value.

Info: Request alignment mode

No data exist. The light curtains set an alignment flag and send alignment value by the next interrupted power-up (details in Chapter 10.1.3).

Data: Reduced state

bit 15		bit 0
	State of light curtain	Door position
bit 0-7	<p>Door position (signed 8 bit): 0 = Door closed 22 = Door open at a 22 element light curtain 52 = Door open at a 52 element light curtain 255 = No information, static mode</p>	
bit 8	<p>State of light curtain: Bit is set if one or more elements below the door edge are interrupted.</p>	
bit 9	<p>Internal failure: Bit is set if an internal failure occurs.</p>	
bit 10-13	<p>Reserved: Reserved values, values not defined (mask out).</p>	
bit 14-15	<p>Maintenance information: 0 = Clean light curtain 1 = Light curtain with light soiling 2 = Light curtain with middle soiling, cleaning at the next opportunity recommended 3 = Light curtain with high soiling, cleaning recommended for a proper functionality</p>	

Data: Full state

bit 79			bit 0
	Single element information	State of light curtain	Door position
bit 0-7	<p>Door position (signed 8 bit): 0 = Door closed 22 = Door open at a 22 element light curtain 52 = Door open at a 52 element light curtain 255 = No information, static mode</p>		
bit 8	<p>State of light curtain: Bit is set if one or more elements below the door edge are interrupted.</p>		
bit 9	<p>Internal failure: Bit is set if an internal failure occurs.</p>		
bit 10-13	<p>Reserved: Reserved values, values not defined (mask out).</p>		
bit 14-15	<p>Maintenance information: 0 = Clean light curtain 1 = Light curtain with light soiling 2 = Light curtain with middle soiling, cleaning at the next opportunity recommended 3 = Light curtain with high soiling, cleaning recommended for a proper functionality</p>		
bit 16-75	<p>Single Element information: bit 16 = Element 1 from bottom, bit is set if the element is interrupted bit 17 = Element 2 from bottom, bit is set if the element is interrupted ... bit 75 = Element 60 from bottom, bit is set if the element is interrupted</p>		
bit 76-79	<p>Reserved: Reserved values, values not defined (mask out).</p>		

NOTICE

- ▶ Length of bit 16 to 79 depends on the number of elements. A edge with 22 elements transmits only 5 full bytes (40 bit).

Safety: Test input

No data exist. The light curtain switches to the test mode (details see Chapter 10.1.2).

Config: Allow change

bit 7	bit 0
Reserved	Change allowed

- bit 0-1 **Change allowed (signed 2 bit):**
 0 = Change is allowed
 1 = Not allowed, stand-by mode not active
 2 = Not allowed, not within 120 second after power-up

bit 2-7 **Reserved:**
 Reserved values, values not defined (mask out).

Config: Set static

bit 7	bit 0
Reserved	Set static

Answer is sent only if mode change has failed.

- bit 0-2 **Set static (signed 3 bit):**
 0 = Static operating mode set but no reset
 1 = Static operating mode not set
 2 = Configuration not read
 3 = Not allowed
 4 = Not allowed, stand-by mode not active
 5 = Not allowed, not within 120 second after power-up

bit 3-7 **Reserved:**
 Reserved values, values not defined (mask out).

Config: Set blanking

bit 7	bit 0
Reserved	Set blanking

Answer is sent only if mode change has failed.

- bit 0-2 **Set blanking (signed 3 bit):**
 0 = Blanking operating mode set but no reset
 1 = Blanking operating mode not set
 2 = Configuration not read
 3 = Not allowed
 4 = Not allowed, stand-by mode not active
 5 = Not allowed, not within 120 second after power-up

bit 3-7 **Reserved:**
 Reserved values, values not defined (mask out).

Config: Get current

bit 7	bit 0
Current mode	

- bit 0-7 **Current mode (signed 8 bit):**
 0x55 = Light curtain in static operation mode
 0xAA = Light curtain in blanking operation mode

9.2.5 CRC-32 (safety-relevant)



bit 31-0 CRC-32 (unsigned 32 bit):

The CRC is calculated using the polynomial

$x^{32} + x^{26} + x^{23} + x^{22} + x^{16} + x^{12} + x^{11} + x^{10} + x^9 + x^7 + x^5 + x^4 + x^2 + x + 1$ (0x04C11DB7) with an initial value of 0xFFFFFFFF.

For the calculation, the CRC-32/MPEG-2 is used.

10. Guidelines for implementation (RS485)

The following sections indicate requirements on the side of the connected control unit for the implementation of safety functions using the GridScan/Pro SI with RS485 interface and its functionalities. The effectively required safety tests must be defined by the system integrator based on and according to the safety requirements of its system design.

10.1 Functions of GridScan/Pro SI

The GridScan/Pro SI with RS485 interface transmits single element information of the light curtain, and in the blanking mode the door position to the control unit. The data can be collected in different communication modes.

The transmitted data frame is a message protected against data corruption using a CRC-32.

The GridScan/Pro SI scans the infrared elements and prepares the following data for the control unit:

- Status of each single element
- Status of the light curtain
- Door position information
- Maintenance information
- Alignment value to optimize the system alignment
- System test to check proper function of the light curtain

The system can be used in the following communication modes:

- Polling mode / default mode
- Full stream mode
- Reduced stream mode
- Stand-by mode
- Alignment mode

10.1.1 Communication modes

The communication with the light curtain can be made in different modes. Each mode can be activated from every communication mode. In case of a failure in the activation of the communication mode, the light curtain switches automatically to the polling mode (default mode).

Power-up sequence

As soon as the communication is initiated, the light curtain sends the *Info: Get Version (0x20)*. This signals the availability of the communication to the control unit. As soon as the light curtain is fully powered and ready to work, the *Data: Reduced state (0x30)* is sent. Thereafter, the light curtain is ready to receive requests from the door control unit.

Polling mode

The polling mode is the default active mode after power-up. The light curtain is active and scans its elements, but no information is shared with the control unit. In this mode, a request for data is needed to receive information from the light curtain.

Full streaming mode

In this mode, the light curtain is active, scans its elements and sends *Data: Full state (0x31)* in each cycle without a request. To stop the data transfer, the light curtain needs to switch in the polling or stand-by mode.

Reduced steaming mode

In this mode, the light curtain is active, scans its elements and sends *Data: Reduced state (0x30)* in each cycle without a request. To stop the data transfer, the light curtain needs to switch in the polling or stand-by mode.

Stand-by mode

In this mode, the light curtain is inactive, no elements are scanned. The communication is active, and requests will be answered. If the command *Data: Full state (0x31)* or *Data: Reduced state (0x30)* are requested, the state of light curtain and elements responds as interrupted.

Alignment mode

In the alignment mode, the light curtain automatically sends an alignment value to align the system in the best position. The alignment value is only available after an interrupted power-up and the alignment mode is activated (first power-up or activation by communication protocol).

10.1.2 System test (safety-relevant)

The test is provided by the communication protocol with command *Safety: Test input (0x40)*. The test input is active until the first information message is sent. The test is successful if all elements switch to interrupted for at least one scanning cycle and reactivate by the next information message.

10.1.3 System alignment

For a proper function, the emitter and receiver need to be mounted in line. The receiver has to be mounted at 180° to the emitter. To optimize the alignment, a value between 0 and 65535 is available by the first start-up in the interrupted state. As soon as the light curtain is free for the first time, the standard operation is available and the alignment mode is disabled. To use the alignment mode a second time, it needs to be activated by the command *Info: Request alignment mode (0x25)*.

The system is installed in the best way, if the alignment value is as low as possible. If the value increases by rotating the light curtain, the alignment gets worse and the light curtain needs to be rotated in the other direction.

10.2 Safety function RS485 CEDES communication protocol

Data transmitted on the RS485 channel uses a safe, proprietary protocol which meets the requirements of SIL 2 as long as the following checks are performed by the door control unit. If any of these checks fails, data are no longer safe according to SIL 2 and the door control unit must initiate an appropriate safety related action.

1. Check timing of received data, as defined in Chapter 10.2.1.
2. Check integrity of received data, as defined in Chapter 10.2.2:
 - Sequence counter must change as expected.
 - Direction bit must be as expected.
 - Transmitted CRC must match with the calculated CRC.
3. Check for internal fault, as defined in Chapter 10.2.3.

Important:

Request from the door control unit will only be responded if the data are valid. If the sequence counter, ID or the check sum is incorrect no data will be responded and a new request is needed.

10.2.1 Check timing of received data

The timing of received data is part of the validation required for safe data transmission.

Parameter to check	Action	Description
Cycle time (time expectation)	Check if the messages are received within the latency time.	Detection of unacceptable delays, missing messages or communication loss.

10.2.2 Check integrity of received data

The integrity of received data is part of the validation required for safe data transmission.

Integrity is validated with the sequence counter and CRC which is calculated over data including the sequence counter.

Parameter to check	Action	Description
Sequence counter	Check if counter increases in increments of 1 for each message (overruns at 255 back to 0).	Detection of data repetition, incorrect sequence, loss or insertion.
CRC-32	Check the CRC-32 according to IEEE 802.3 by using the polynomial $x^{32} + x^{26} + x^{23} + x^{22} + x^{16} + x^{12} + x^{11} + x^{10} + x^8 + x^7 + x^5 + x^4 + x^2 + x + 1$ (0x04C11DB7) with an initial value of 0xFFFFFFFF. For the calculation, the CRC-32/MPEG-2 is used.	Detection of corrupted data.
Direction bit	Check if the direction bit is set for the right direction.	Detection of corrupted data.

10.2.3 Check timing of received data

If an internal fault is active, the correctness of the data is not guaranteed. This means, even if the validation of received data is successful, the information can be wrong.

Parameter to check	Action	Description
Error / Warning	Check that no internal fault is active.	Detection of irregular function of the GridScan/Pro SI.

NOTICE

- ▶ Internal fault is active if bit 9 internal failure in the state of light curtain byte is set.

10.3 Implementation of RS485 CEDES communication protocol (RC)

For the implementation, the command *Info: Communication test (0x23)* can be used. The package of this command is processed even if the information is not correct and helps to implement the protocol to the door control unit. Below an example how to use the command:

- Send a request with only the command: *0x23*

Request:

Byte	0	1	2	3	4	5	6	7	8	9
Info [HEX]	00	00	00	00	00	23	00	00	00	00

Response:

Byte	0	1	2	3	4	5	6	7	8	9	10
Info [HEX]	43	45	44	45	01	A3	07	EF	30	3F	78

- Send a second request with the same command, increasing the sequence counter.

Request:

Byte	0	1	2	3	4	5	6	7	8	9
Info [HEX]	00	00	00	00	02	23	00	00	00	00

Response:

Byte	0	1	2	3	4	5	6	7	8	9	10
Info [HEX]	43	45	44	45	03	A3	05	8F	52	0C	72

6. Send a third request with the command and now add the sync pattern.

Request:

Byte	0	1	2	3	4	5	6	7	8	9
Info [HEX]	43	45	44	45	04	23	00	00	00	00

Response:

Byte	0	1	2	3	4	5	6	7	8	9	10
Info [HEX]	43	45	44	45	05	A3	01	41	CF	DB	65

7. Complete the protocol with the correct CRC-32 checksum.

Request:

Byte	0	1	2	3	4	5	6	7	8	9
Info [HEX]	43	45	44	45	06	23	E2	4B	01	70

Response:

Byte	0	1	2	3	4	5	6	7	8	9	10
Info [HEX]	43	45	44	45	07	A3	00	F8	8B	AB	62

If the Byte 6 has the value 00, the protocol is implemented correctly, and the information can be collected from the light curtain.

10.4 Change of operation mode (blinking into static mode)

If the mounting is static, the operating mode from blinking into static needs to be changed by a defined sequence of commands. The sequence is defined below. The same sequence is used to change the operating mode back to the delivery configuration (blinking mode). The sequence needs to be conducted within the first 120 s after power-up.

1. Power-up
2. Enter stand-by mode by command *Mode: Set stand-by (0x13)*
3. Allow configuration change by command *Config: Allow change (0x50)*
4. Read the current configuration by command *Config: Get current (0x53)*
5. Set the new operating mode by command *Config: Set static (0x51)* for static mounting or *Config: Set blinking (0x52)* for blinking mounting. If the change of the operating mode is successful, the GridScan/Pro SI restarts automatically. The mode has changed. The static mode is visible after the power-up with a blinking sequence of green and off.

11. System timing (RS485)

The system transmits a message to the control unit after finishing of the scanning cycle (t_{CYCLE}) if a request has been received during the scanning cycle. The status information of the single elements or light curtain will be updated during every main loop. In the streaming mode, the updated data is transmitted after a full main loop. If an additional request is received, the request is answered first, followed by the streaming information.

Important: The GridScan/Pro SI can handle only one request per t_{CYCLE} .

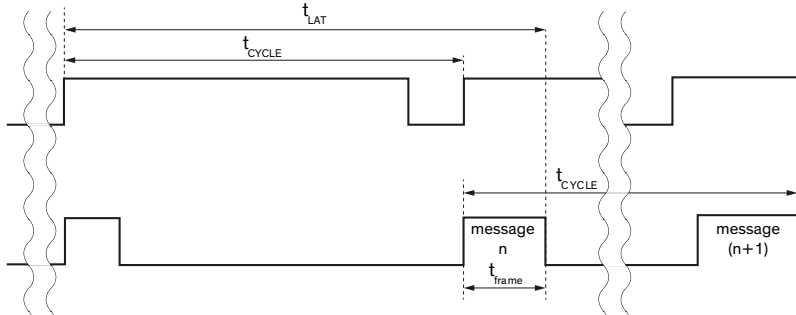

Figure 11: System timing overview

Symbol	Parameter	Min.	Typ.	Max.	Unit
t_{CYCLE}	- Sampling cycle time at 22 elements - Transmission cycle time at 22 elements	18	30	40	ms
t_{CYCLE}	- Sampling cycle time at 60 elements - Transmission cycle time at 60 elements	48	62	76	ms
t_{frame}	Duration for message transmission	0.9	1.2	1.8	ms
t_{LAT}	Latency time at 22 elements; time from starting scanning until the message is transmitted ($t_{CYCLE} + t_{frame}$)	18.9	31.2	41.8	ms
t_{LAT}	Latency time at 60 elements; time from starting scanning until the message is transmitted ($t_{CYCLE} + t_{frame}$)	48.9	63.2	77.8	ms

Response time					
	Power-up time			1,700	ms
	Response time			$2 \times t_{LAT}$	ms
	Test response time			$2 \times t_{LAT}$	ms

Table 1: System Timing (RS485 at 115.2 kBit/s)

12. Start-up

1. Make sure that the door is open by the power-up.
2. Switch on mains and power-up the door control unit. The LED on the receiver edge blinks during the start-up phase.
3. Check the LED on both edges (power, status).
4. If needed, change the mode according to the manual of the door control unit.
5. Test if the system is working correctly.

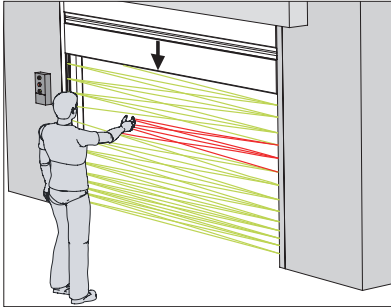

1. Interrupt the light curtain and check if the LED status on receiver edge changes.
2. Start a door closing cycle and interrupt the light curtain again. The door must stop closing and open again (depending on the door control setting).
3. **For static mode only:** Interrupt the highest element of the light curtain and check if the LED status on the receiver edge changes.

NOTICE

Important: If the light curtain is already in static mode during installation, the system must be set to the delivery configuration (blinking mode) according to Chapter 10.4 to ensure proper operation. Thereafter the static mode can be activated again.

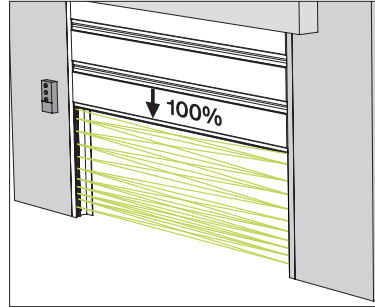

Start a complete door closing cycle and check that the door closes completely without problems.

13. LED status description

Receiver edge (Rx)

Green LED	Red LED	Sensor status
●	○	Light curtain free
○	●	Safeguarded area interrupted
○	⦿	Start-up (slow blinking)
○	⦿	Internal malfunction (fast blinking)
○	○	No power or edge is defective (see Chapter 13)
⦿	○	Static mode configured (blinking with 1 Hz / ≤2 min)

Table 2: LED status description receiver edge

● = LED on ○ = LED off ⦿ = LED blinking

Emitter edge (Tx)

Green LED	Sensor status
●	Power OK
○	No power or edge is defective (see Chapter 14)

Table 3: LED status description emitter edge

14. Troubleshooting

Tx LED Green	Rx LED Green	Rx LED Red	Action
LED off	LED off	LED off	<ul style="list-style-type: none"> ▶ Check electrical connections. ▶ Check supply voltage of the door controller.
LED off	LED off	LED red	<ul style="list-style-type: none"> ▶ Check the connection of the synchronization cable.
LED green	LED green	LED off	<ul style="list-style-type: none"> ▶ Make sure the sensor edges are not mounted close to any shiny or reflective surface. ▶ Restart the system.
LED off/on (flickering green)	LED off	LED off/on (flickering red)	<ul style="list-style-type: none"> ▶ Check power supply. ▶ Check connections.
LED green	LED off	LED off/on (slow blinking red)	<ul style="list-style-type: none"> ▶ Make sure the safeguarded area is clear of interruption. ▶ Check the alignment of the light curtain. ▶ Clean elements.
LED green	LED on/off (flickering green)	LED off/on (flickering red)	<ul style="list-style-type: none"> ▶ Make sure the safeguarded area is clear of interruption. ▶ Clean the elements. ▶ Make sure that the cables and edges are located away from sources of electromagnetic interference. ▶ Ensure that the emitter and receiver are correctly aligned and remain so during door closure (e.g. that vibrations do not cause edges to become misaligned). ▶ Restart the system.
LED green	LED off	LED red	<ul style="list-style-type: none"> ▶ Make sure the safeguarded area is clear of interruption. ▶ Reopen door completely. ▶ Clean the elements. ▶ Check the alignment of the light curtain. ▶ Check power supply. ▶ Restart the system.
LED off	LED off	LED off/on (slow blinking red)	<ul style="list-style-type: none"> ▶ Check the connection of the synchronization cable.
LED green	LED off	LED off/on (red, fast blinking, 5 Hz)	<p>Internal error occurred</p> <ul style="list-style-type: none"> ▶ Restart the system. ▶ Replace Rx edge.
LED green	LED blinking	LED off	<ul style="list-style-type: none"> ▶ Check if the selected configuration is correct (static mode selected)

Important: Whenever a parameter is changed, the system must be restarted.
 If a problem persists, please contact your local CEDES representative. Visit www.cedes.com for contact data.

15. Maintenance

Although the GridScan/Pro SI does not need regular maintenance, a periodic functional check is strongly recommended:

- ▶ Make sure the optical elements are clear of dirt and dust. If necessary, clean the front surface with a soft towel.
- ▶ Make sure the edges are securely fastened.
- ▶ Check the mounting position, cable routing and connection of the sensor.

NOTICE

Damage to the optical elements

- ▶ Never use any solvents, cleaners or mechanically abrasive towels or high-pressure water to clean the sensor.
- ▶ Avoid scratching the optical elements while cleaning.

16. Disposal

The GridScan/Pro SI should only be replaced if a similar protection device is installed. Disposal should be done using the most up-to-date recycling technology according to local regulations and laws. There are no harmful materials used in the design and manufacture of the sensor. Traces of such dangerous materials may be found in the electronic components but not in quantities that are harmful.

17. Technical data

Optical

Operating range	1...10 m (3 ... 33 ft)
Number of elements	12 ... 60 (depending on edge length and resolution)
Max. protection height	2,500 mm (98.5 in)
Min. resolution:	
- 0 ... 500 mm	Test body B acc. to EN 12453:2017
- 0 ... 2,500 mm	Test body A acc. to EN 12453:2017
Max. ambient light	100,000 Lux

Mechanical

Cross section	12 mm × 14.5 mm (0.47 in × 0.57 in)
Mounting holes	Ø 4.3 mm (0.17 in)
Housing material	Natural anodized aluminum
Enclosure rating	IP68 (Cable: IP67)
Temperature range	-40 °C ... +60 °C (-40 °F ... +140 °F)

Electrical

Supply voltage U _{Sp}	10 ... 30 VDC
Current consumption with 22 elements at 24 VDC	50 mA
Output	Serial interface RS485
Termination of RS485	120 Ω (internally)
Typ. response time with 22 elements	40 ms
Max. response time with 22 elements	83.6 ms
HW Watch dog	200 ms
Max. door closing speed	1.6 m/s
Max. door opening speed	> 3 m/s
Status LED Rx:	
- Object detected	Red
- No object detected	Green
Power LED Tx:	
Power ok	Green

Connection cable and electrical connection

Synchronization cable

Length	10 m (33 ft)
Connection	Screwable M8, 4 pin
Diameter	Ø 3.5 mm (Ø 0.14 in)
Material	PVC, black
Plug color	Black
Wires	AWG26
• brown	U _{Sp}
• blue	GND (0 V)
• black	Communication
• white	Not used

Connection cable

Length	5 m (16.5 ft)
Connection	Screwable M8, 4 pin
Diameter	Ø 4.2 mm (Ø 0.17 in)
Material	PVC, black
Plug color	Blue
Wires	AWG26
• brown	U _{Sp}
• blue	GND (0 V)
• black	Not used
• white	Not used
• gray	RS485 Data B
• green	RS485 Data A

General

EMC emission	EN 61000-6-3:2007 EN 12015:2014
EMC immunity	EN 61000-6-2:2019 EN 12016:2013
Vibration	IEC 60068-2-6:2007
Shock	IEC 60068-2-27:2008
RoHS	2011/65/EU
Certificates	CE, TÜV
Safety categories	EN ISO 13849-1:2015, Cat. 2, PL d EN 61508:2010, SIL 2 EN 61784-3:2017 EN 12978:2003, +A1:2009 EN 12453:2017 E device

18. Dimensions

All dimensions in mm (for 22 elements)

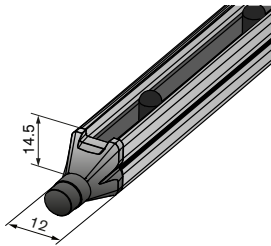
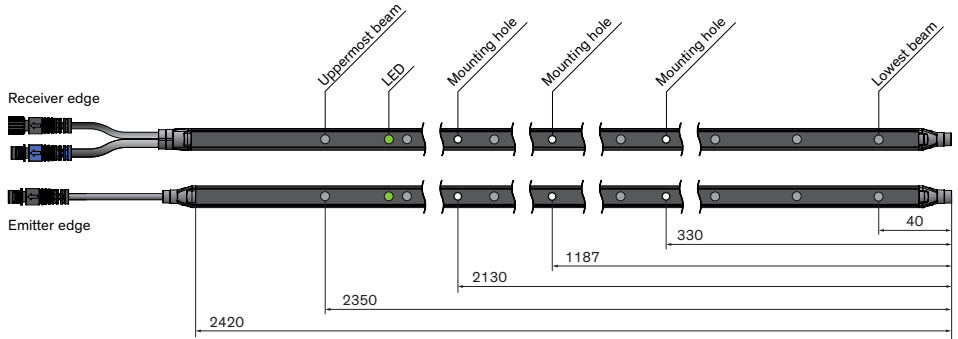

US measurements

All dimensions in inches (for 22 elements)

